

25
26

WORKBOOK |



KOMPERDELL



04
WE ARE KOMPERDELL



08
RACING



36
BIG MOUNTAIN



48
JUNIOR



54
RENTAL



64
TOURING



76
SNOWSHOES



84
NORDIC XC



90
PROTECTION



116
TREKKING

144
NORDIC WALKING



150
ACCESSORIES



Top-level sport has always been an integral part of our DNA. Together with our athletes, we are constantly developing new and better solutions to always be one pole length ahead.”

Toni Lorenz and Andreas Lorenz, racing team

In my opinion, Komperdell stands for exactly what is necessary and essential in the Alpine Ski World Cup: Perfect material, reliability, durability and most important, familiar atmosphere!

Marco Schwarz
Marco Schwarz



„With Komperdell green poles = green light.“

Federica Brignone
Federica Brignone



Why Komperdell? I very much appreciate the service and the excellent quality.

Petra Vlhova
Petra Vlhova



Komperdell is for me the very best choice for years.

Henrik Kristoffersen
Henrik Kristoffersen



This year, we're launching a firework of innovations. Get ready for a year full of new products that will excite you."

Thomas Roiser, CEO KOMPERDELL



CUSTOMIZED POLES – 100% MADE IN AUSTRIA

Apart from our own brand we develop, design and manufacture individual solutions for more than 40 leading ski and protection brands. Our production in Austria is not only very sustainable, but offers highest flexibility and rapid response times. Our customers benefit from years of know-how and cutting-edge technology. We are also happy to create a customized product exclusively for you, tailored to your specific needs and desires.



ZERO WASTE PROGRAM

We do not believe in labels and certificates. Our approach to a more sustainable production is simple and honest. Our goal is to produce our poles without a single gram of waste by ensuring that all materials are recycled and returned to the production cycle directly on-site.



REPAIR SERVICE

We launched our 3-year free repair service more than 15 years ago. No questions asked – no matter if it is our customers' fault or ours. Our service is part of our belief that quality products must be backed by outstanding service.

CHAMPION'S CHOICE

We are the most successful racing brand in history.
The world's best athletes trust in us for decades!

RACING
BIG MOUNTAIN
JUNIOR
RENTAL
TOURING
SNOWSHOES
NORDIC XC
PROTECTION
TREKKING
NORDIC WALKING
ACCESSORIES



 **Henrik Kristoffersen**
World Champion Giant Slalom
World Champion Slalom
triple Slalom World Cup Globe winner
Giant Slalom World Cup Globe winner
two Olympic medals

+ PUNCH PROTECTION VARIANTS:



PUNCH COVER
World Cup

art. # 156-48



PUNCH COVER
Profi

art. # 158-48



PUNCH COVER
Small

art. # 152-48

RACING WORLD CUP

BRAND
NEW



punch protection
made of highly resistant thermoplastic resin, absorbs hard impacts

shrinking tube
reinforcing of the shaft

solid screw joint
for extra tight fit and no twisting of the punch protection

shrinking tube
reinforcing of the shaft

NATIONALTEAM Carbon Slalom 12,3

Sizes:
· 100-140cm (in 5cm steps)

Features:
· technical grip with rubber
· race strap
· shrinking tube included
· Carbon, Ø 12,3 mm
· mini race basket
· flex carbide race tip

art. # 147 32 56-48

NATIONALTEAM Carbon Slalom 12,3

Sizes:
· 100-140cm (in 5cm steps)

Features:
· technical grip with rubber & punch cover World-Cup style
· race strap
· shrinking tube included
· Carbon, Ø 12,3 mm
· mini race basket
· flex carbide race tip

art. # 147 32 51-48

baskets & tips
fixed with special glue for extra strong holding force

shrinking tube
reinforcing of the shaft

NATIONALTEAM Carbon Slalom 12,3

Sizes:
· 100-140cm (in 5cm steps)

Features:
· technical grip with rubber & punch cover World-Cup style
· race strap
· shrinking tube included
· Carbon, Ø 12,3 mm
· mini race basket
· flex carbide race tip

art. # 147 32 56-48

Marco Schwarz
 World Champion in Combination
World Championships Bronze Slalom
2x World Championships Bronze Giant Slalom
Slalom World Cup Globe winner



RACING
BIG MOUNTAIN
JUNIOR
RENTAL
TOURING
SNOWSHOES
NORDIC XC
PROTECTION
TREKKING
NORDIC WALKING
ACCESSORIES

RACING WORLD CUP

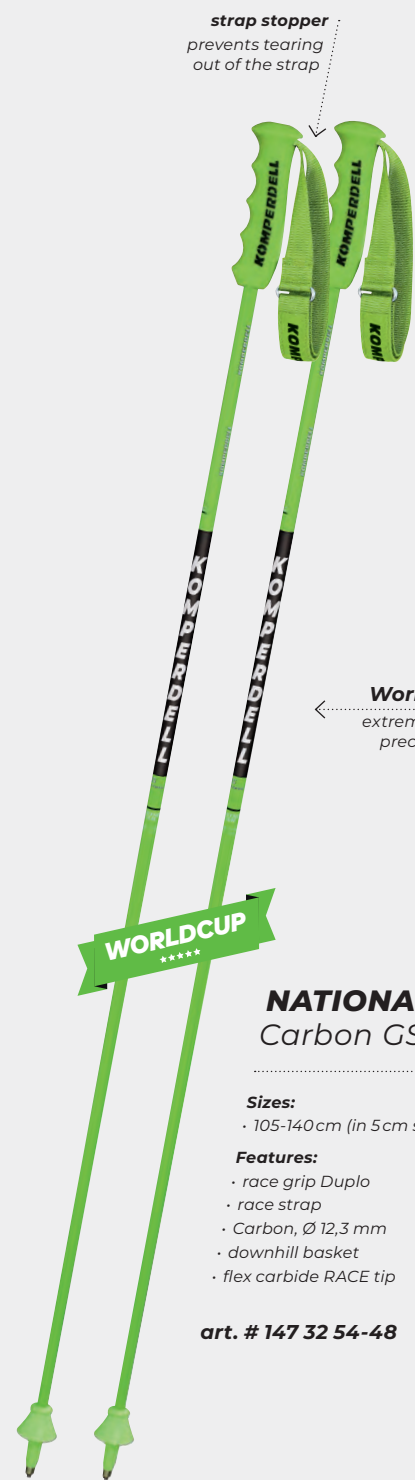

strap stopper prevents tearing out of the strap

World Cup equipment extremely stiff materials and precise manufacturing for highest demands

NATIONALTEAM Carbon GS 12,3

- Sizes:**
- 105-140cm (in 5cm steps)
- Features:**
- race grip Duplo
 - race strap
 - Carbon, Ø 12,3 mm
 - downhill basket
 - flex carbide RACE tip

art. # 147 32 54-48



race grip offers perfect grip and a secure feeling

NATIONALTEAM Carbon GS Bent

- Sizes:**
- 115-140cm (in 5cm steps)
- Features:**
- race grip Duplo
 - race strap
 - Carbon, Ø 16/10 mm, bent
 - downhill basket
 - flex carbide race tip

art. # 148 10 54-48



Petra Vlhova
Giant Slalom World Champion
Olympic Gold in Slalom
Overall World Cup Winner
double Slalom World Cup Globe Winner

© GEPA-Pictures

Sofia Goggia
Olympic Gold Downhill
Olympic Silver Downhill
World Championships Silver Super-G
World Championships Bronze Giant Slalom
4-time Downhill World Cup winner

Sofia Goggia

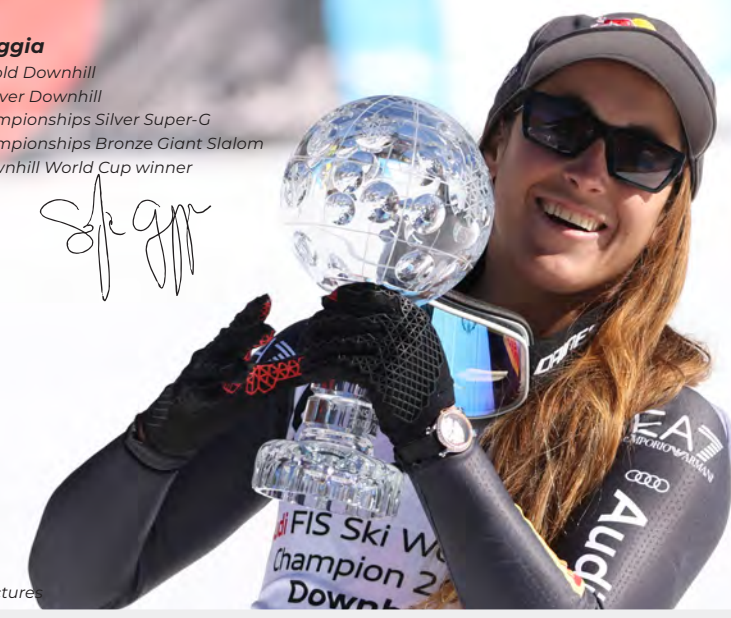

© GEPA-Pictures



bent Carbon aerodynamic bend for maximum speed

NATIONALTEAM Carbon Super-G

- Sizes:**
- 120-140cm (in 5cm steps)
- Features:**
- race grip Duplo
 - race strap
 - Carbon, Ø 16/10 mm, bent
 - downhill basket
 - flex carbide race tip

art. # 148 10 52-48



NATIONALTEAM Carbon Downhill

- Sizes:**
- 120-140cm (in 5cm steps)
- Features:**
- race grip Duplo
 - race strap
 - Carbon, Ø 16/10 mm, bent
 - downhill basket
 - flex carbide race tip

art. # 148 10 53-48



Vincent Kriechmayr
World Champion Downhill
World Champion Super-G
World Cup winner

© GEPA-Pictures

RACING WORLD CUP



 **James Crawford**
World Champion Super-G
Olympic Bronze Alpine Combined

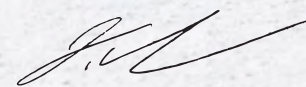

© GEPA-Pictures



CLICK-IN Skicross strap
keeping the hands free
at the starting gate

World Cup equipment
extremely stiff materials and
precise manufacturing for
highest demands

Carbon shaft with TI CORE
for maximum performance

NATIONALTEAM Carbon Skicross TI Core

- Sizes:**
- 115-140cm (in 5cm steps)
- Features:**
- 2-K touring click-in grip
 - click-in skicross strap
 - Carbon, Ø 16 mm TI core bent
 - mini race basket
 - flex carbide race tip

art. # 148 10 58-48

RACING CARBON



race strap
easy to adjust
for perfect fit
and comfort

junior-edition
The perfect racing pole made of
extra light Carbon for tomorrow's
winner!

NATIONALTEAM Carbon Junior

- Sizes:**
- 85-115 cm (in 5 cm steps)
- Features:**
- Kids Race rubber grip
 - race strap
 - Carbon, Ø 13/9mm
 - mini race basket
 - tungsten/carbide flex tip

art. # 146 42 02-48

high performance Carbon
We develop our own Carbon tubes.
Top-quality japanese Carbon
fibers in combination with our
unique production technique and
resins result in top quality Carbon
poles with breaking points up to
200 kg's.

NATIONALTEAM Carbon

- Sizes:**
- 110-135 cm (in 5 cm steps)
- Features:**
- race grip rubber
 - race strap
 - Carbon, Ø 13/9mm
 - mini race basket
 - tungsten/carbide flex tip

art. # 146 42 01-48



© GEPA-Pictures

RACING ALUMINUM

Light, but strong as steel. For our Aluminum racing poles we use only the toughest Aluminum in combination with our proprietary heat treatment process. Resulting in the superior quality our athletes demand and need.

RACING
BIG MOUNTAIN
JUNIOR
RENTAL
TOURING
SNOWSHOES
NORDIC XC
PROTECTION
TREKKING
NORDIC WALKING
ACCESSORIES



 **Federica Brignone**
World Champion Alpine Combined
Overall World Cup winner
triple Olympic medals



WORLD CUP

NATIONALTEAM Alu Slalom 19 mm

- Sizes:**
- 100-135cm (in 5cm steps)
- Features:**
- technical grip with rubber & punch cover World-Cup style
 - race strap
 - Aluminum 7075-T6, Ø 19 mm
 - mini race basket
 - tungsten/carbide flex tip

art. # 144 42 51-48

+ PUNCH PROTECTION VARIANTS:



PUNCH COVER
World Cup

art. # 156-48



PUNCH COVER
Profi

art. # 158-48



PUNCH COVER
Small

art. # 152-48

RACING ALUMINUM



WORLD CUP

NATIONALTEAM Alu Super-G 19 mm

- Sizes:**
- 100-135cm (in 5cm steps)
- Features:**
- race grip Duplo
 - race strap
 - Aluminum 7075-T6, Ø 19 mm bent
 - downhill basket
 - tungsten/carbide flex tip

art. # 144 42 50-48



WORLD CUP

NATIONALTEAM Profi 19 mm

- Sizes:**
- 100-135cm (in 5cm steps)
- Features:**
- race rubber grip
 - race strap
 - Aluminum 7075-T6, Ø 19 mm
 - mini race basket
 - tungsten/carbide flex tip

art. # 144 42 01-48



 **Cornelia Hütter**
Downhill Globe winner
World Cup winner
World Championship bronze
Super - G

RACING
BIG MOUNTAIN
JUNIOR
RENTAL
TOURING
SNOWSHOES
NORDIC XC
PROTECTION
TREKKING
NORDIC WALKING
ACCESSORIES

RACING ALUMINUM



NATIONALTEAM Super-G 18 mm

- Sizes:**
- 110-135cm (in 5cm steps)
- Features::**
- rubber race grip
 - race strap
 - Aluminum 7075-T6, Ø 18 mm
 - downhill basket
 - tungsten/carbide flex tip

art. # 134 42 02-48

Super-G pole
made of extremely strong Aluminum 7075-T6 with aerodynamical Super-G bending

High-End Aluminum
Ingredients of zinc and magnesium together with a complex alloying technique result in extreme strength, similar to steel.

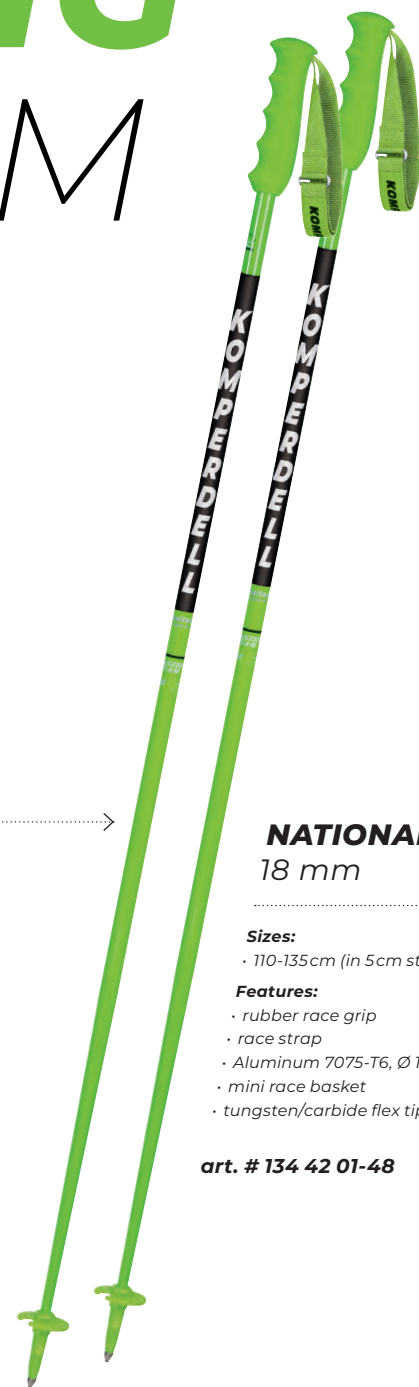

NATIONALTEAM 18 mm

- Sizes:**
- 110-135cm (in 5cm steps)
- Features:**
- rubber race grip
 - race strap
 - Aluminum 7075-T6, Ø 18 mm
 - mini race basket
 - tungsten/carbide flex tip

art. # 134 42 01-48



Alexander Steen Olsen
 **Alexander Steen Olsen**
 World Cup winner
 Junior world champion slalom and giant slalom

© GEPA-Pictures



Floris Wondergem
born in 2010

© 247sportphoto



NATIONALTEAM Super-G Junior

- Sizes:**
- 85-115cm (in 5cm steps)
- Features:**
- Kids race grip (length 85 - 95cm) / Junior race grip (length 100 - 115cm)
 - race strap
 - Aluminum 7075-T6, Ø 16 mm
 - downhill basket
 - tungsten/carbide flex tip

art. # 224 42 02-48

junior-edition
Nationalteam poles made of extremely strong Aluminum for true Worldcup feeling!

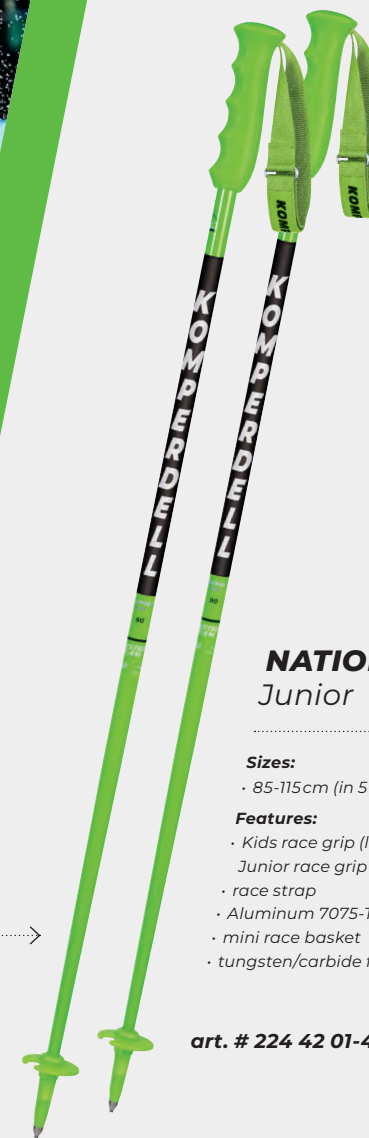

NATIONALTEAM Junior

- Sizes:**
- 85-115cm (in 5cm steps)
- Features:**
- Kids race grip (length 85 - 95cm) / Junior race grip (length 100 - 115cm)
 - race strap
 - Aluminum 7075-T6, Ø 16 mm
 - mini race basket
 - tungsten/carbide flex tip

art. # 224 42 01-48

- Junior Race grip**
length 100-115cm
- Kids Race grip**
length 85-95cm



Finn Erlandsson
born in 2017

RACING GUARDS

We established our own Carbon development and production facilities more than 20 years ago. We use only the highest quality Carbon fibres and resins for the production of our lightweight and yet extremely tough shin- and elbow guards.



ELBOW GUARDS

individually adaptable

screws and straps
for your optimal
position and best hold



strap length can be easily
changed with pre-made
hole variants and
screw connections

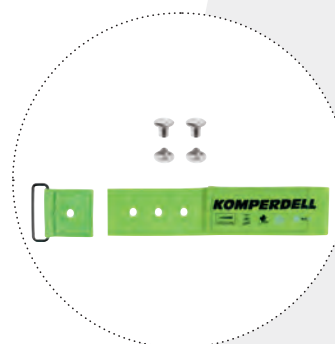

Protector foam
inside

The thickness of the inside material with impact protection is adaptable – multiple layers can be additionally attached for better fit.



material in
center reinforced
optimum protection
against bouncing bars

flexible outer edge
suitable for any leg or
calve size



modified form
for better fit
on the forearm

CARBON ELBOW PROTECTION World Cup

art. # 6537-48

ELBOW PROTECTION World Cup

art. # 6623-213 adult
art. # 6625-213 junior

RACING
BIG MOUNTAIN
JUNIOR
RENTAL
TOURING
SNOWSHOES
NORDIC XC
PROTECTION
TREKKING
NORDIC WALKING
ACCESSORIES

RACING
BIG MOUNTAIN
JUNIOR
RENTAL
TOURING
SNOWSHOES
NORDIC XC
PROTECTION
TREKKING
NORDIC WALKING
ACCESSORIES

SHIN GUARDS

RACING
BIG MOUNTAIN
JUNIOR
RENTAL
TOURING
SNOWSHOES
NORDIC XC
PROTECTION
TREKKING
NORDIC WALKING
ACCESSORIES



positions of the straps
are freely selectable
pre-made marking
for frequently used
hole positions

shorten to
individual length
length of the shinguard can
be shortened by up to 10 cm –
close fitting with the boot

The strap course is freely
selectable between
parallel and cross.

Protector foam
inside

The thickness of the inside material with
impact protection is adaptable – multiple
layers can be additionally attached for
better fit.

CARBON SHINGUARD World Cup

art. # 6535-48

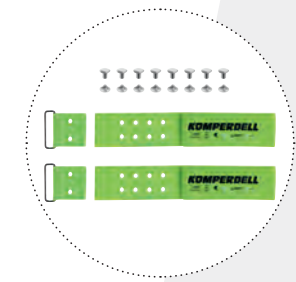
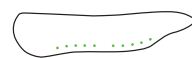

leading edge
ensures that the slalom gates
slide off to the outside

reinforced surface
provides perfect
protection for the full
length of the shin

flexible outer edge
suitable for any leg or
calve size

SHINGUARD Profi World Cup

Features:
- individual fit

art. # 6622-213 adult
art. # 6624-213 junior

strap length can be easily changed
with pre-made hole variants and
screw connections



positions of the straps
are freely selectable
marked hole positions

shorten to
individual length
close fitting with the boot



RACING
BIG MOUNTAIN
JUNIOR
RENTAL
TOURING
SNOWSHOES
NORDIC XC
PROTECTION
TREKKING
NORDIC WALKING
ACCESSORIES

RACING GLOVES

Perfect protection for our racers. Our racing gloves are made of ultra soft but thus durable genuine leather to ensure a perfect balance between haptic and protection for the racer.



RACING GLOVE Junior

Sizes:
· XS-XL

- Features:**
- genuine leather
 - special thermal insulation
 - shock absorbing foam at finger, thumb and back of the hand

art. # 6620-02 junior



RACING LOBSTER Junior

Sizes:
· XS-XL

- Features:**
- genuine leather
 - special thermal insulation
 - shock absorbing foam at finger, thumb and back of the hand

art. # 6621-02 junior



RACING GLOVES



seams at the outside
no irritating seams on the fingertips



expanded knuckle protection
made of Carbon

padding in armadillo principle
flexible punch protection



extremely warm & genuine leather

non-slip palm
for best grip

tough stuff material
extremely abrasion resistant – also used in motorcycling



RACING GLOVE

Sizes:
· XS-XL

- Features:**
- genuine leather
 - special thermal insulation
 - knuckle protection made of Carbon (only Adult)
 - shock absorbing foam at finger, thumb and back of the hand

art. # 6501-02 adult

RACING LOBSTER

Sizes:
· XS-XL

- Features:**
- genuine leather
 - knuckle protection made of Carbon (only Adult)
 - shock absorbing foam at finger, thumb and back of the hand

art. # 6502-02 adult

RACING PROTECTION

BRAND NEW



removable strap system
eliminates pressure points

top residual force values

Height-adjustable kidney belt
for perfect fit

multi impact capable

PROTECTOR PACK

Sizes:

- Men: XXS-XL
- Junior: 128-152

Features:

- multilayer Cross Flex back-protector made of adaptive dual-density foam, EN-approved 1621-2, level 2
- confirms to FIS regulations
- anatomic shaped back for best fit
- new detachable strap system – shoulder it like a backpack
- protector insert visible - part of the design concept
- ultimate freedom of movement
- height-adjustable kidney belt for perfect fit, adjustable with velcro and plush

art. # 6696-2 men
art. # 6697-2 junior



removable strap system
eliminates pressure points

meets FIS regulations

Height-adjustable kidney belt
for perfect fit



back protection
multilayer Cross 6.0 protector
for perfect protection

FULL PROTECTOR Slalom Shirt Long

Sizes:

- Adult: XS-XL
- Junior: 116-152

Features:

- perfect breathability, comfortable to wear
- multilayer Cross 6.0 back-protector, made of adaptive dual-density foam, EN-approved 1621-2, level 2
- perfect protection of back, shoulders, shoulderblades & arms

art. # 6301-208 adult
art. # 6302-208 junior

perfect protection for shoulders and arms
Inserts made of high-quality dual-density protector foams offer optimal protection



PROTECTOR Slalom Shirt

Sizes:

- Adult: XS-XL
- Junior: 116-152

Features:

- perfect breathability, comfortable to wear
- body-shape cut
- multilayer protectors made of dual-density foam
- perfect protection of shoulders, shoulderblades and arms
- specially shaped back for perfect combination with the protector Pack

art. # 6283-02 adult
art. # 6284-02 junior



RACING BAGS



back-strap system can be stowed away

NATIONALTEAM Ski Boot Bag

- Features:**
- Ski boots to be stored either in the main compartment or in the side pockets (dry compartment)
 - sections in the main compartment (e.g. for helmet, goggles, punch guards)
 - adjustable and padded shoulder-straps, straps for chest and waist
 - back-straps can be stowed away
 - waterproof bottom construction
 - measurements 600x500x350 mm
 - total volume 72 l

art. # 6503-208

several compartments with partitions for goggles, helmet and punch guards



waterproof bottom-construction

side pockets to store ski-boots or other accessories



carry-system can be adjusted to the individual center of gravity

total length 220cm expanded

NATIONALTEAM Expandable Pole & Ski Bag with wheels

- Features:**
- capacity for 4 pair of skis plus poles
 - integrated straps with non-slip fixing
 - reinforced and padded bottom
 - integrated wheels
 - carry-system can be adjusted to the individual center of gravity
 - total length 150 cm/109.2liters
 - expandable in length for 70cm to 220cm/60.16liters
 - packed size 75cm

art. # 6500-02

total length 150 cm compact



packed size 75x28 cm

wheels for easy transport

2 straps on the inside to secure the skis



side pockets storage options for ski boots or helmet

total length 220 cm expanded on both ends



NATIONALTEAM Expandable Pole & Ski Bag

- Features:**
- capacity for 4 pair of skis plus poles
 - integrated straps with non-slip fixing
 - tear-proof and robust
 - total length 150cm/109.2liters
 - expandable on both ends for 35cm to a total of 220cm/160.16l

art. # 6414-02

total length 150 cm compact

personalization possible

RACING | BIG MOUNTAIN | JUNIOR | RENTAL | TOURING | SNOWSHOES | NORDIC XC | PROTECTION | TREKKING | NORDIC WALKING | ACCESSORIES

RACING | BIG MOUNTAIN | JUNIOR | RENTAL | TOURING | SNOWSHOES | NORDIC XC | PROTECTION | TREKKING | NORDIC WALKING | ACCESSORIES

AIRFOAM GRIP



THE REVOLUTION IN GRIP TECHNOLOGY

Combining the best of two worlds, the new Airfoam grip offers the lightweight comfort of foam and the secure grip of rubber. Thanks to a unique foaming process, the grip is 40% lighter than conventional rubber grips without sacrificing any grip. Super soft but providing best grip – a grip feeling that you can't find anywhere else.



Easy handling
Simply thread the ring over the handle head and off you go!

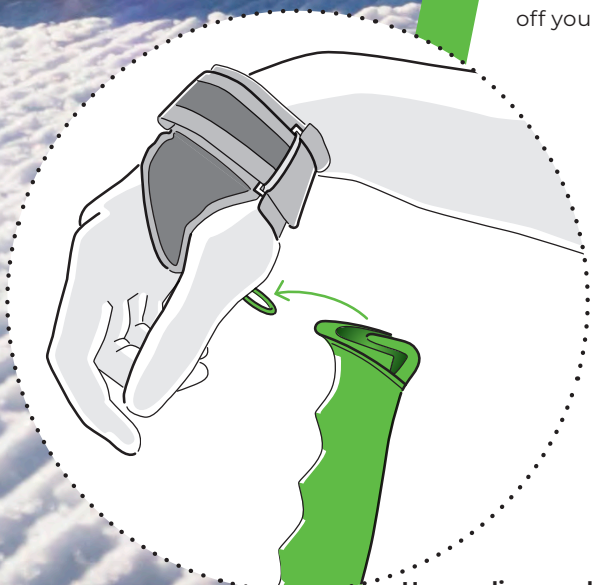

Uncoupling made easy
Pull the hand forwards over the grip head. Uncouple the ring with a short pull.

SPECIAL GRIP SHAPE
to adjust conventional touring bindings

GRIP GEOMETRY
guarantees rock-solid hold of the strap

NEW SIDEWINDER-STRAP SYSTEM
for easy handling

PERFECT GRIP
thanks to modern and ergonomic design

INNOVATIVE AIRFOAM-MATERIAL
for a pleasant and non-slip feel

40% LIGHTER



RESORT SIDEWINDER

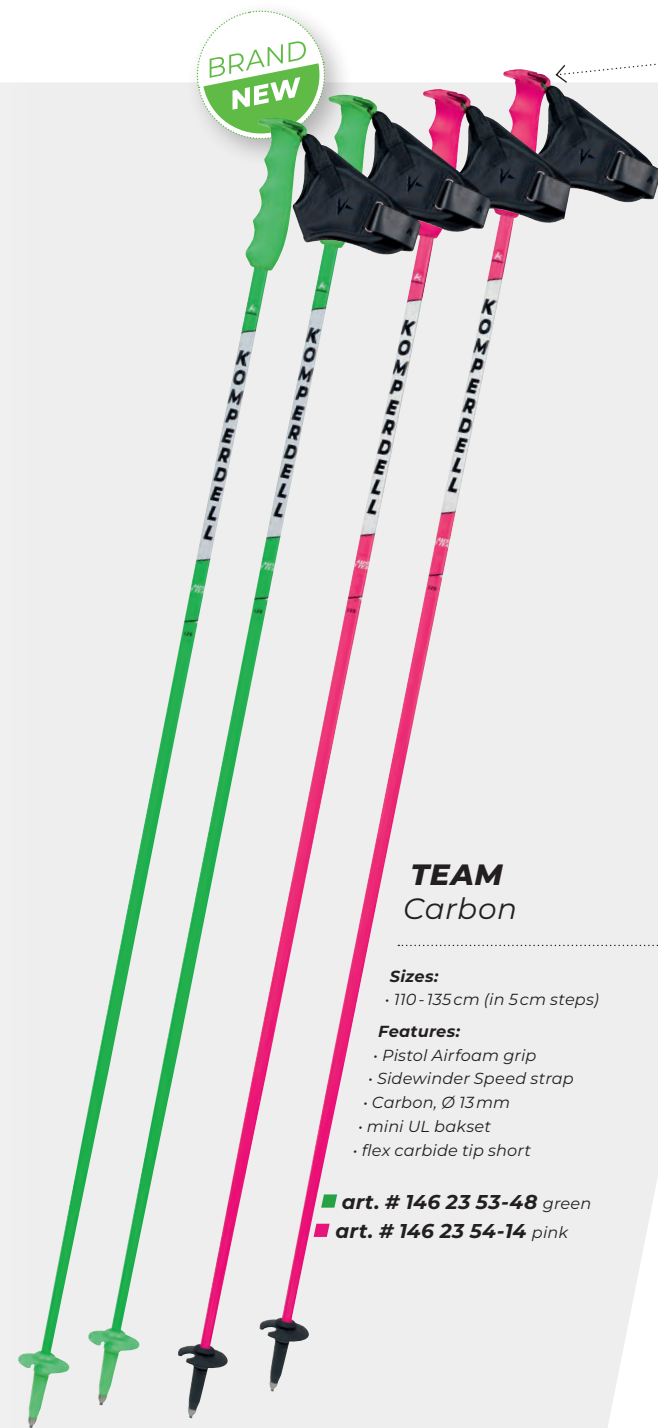

TEAM Carbon

Sizes:
· 110-135cm (in 5cm steps)

- Features:**
- Pistol Airfoam grip
 - Sidewinder Speed strap
 - Carbon, Ø 13mm
 - mini UL bakset
 - flex carbide tip short

- art. # 146 23 53-48 green
- art. # 146 23 54-14 pink

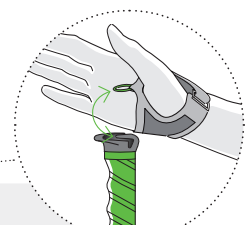

new Sidewinder strap system
easy and safe to use

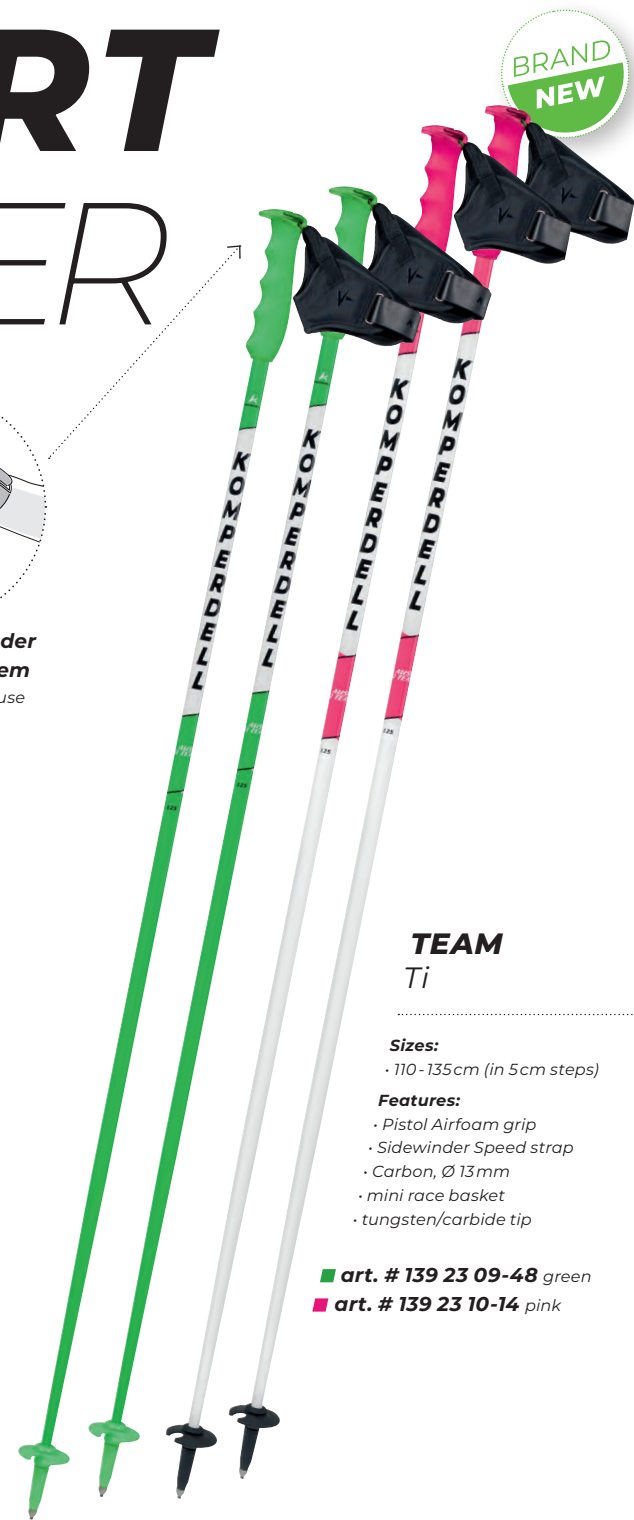

TEAM Ti

Sizes:
· 110-135cm (in 5cm steps)

- Features:**
- Pistol Airfoam grip
 - Sidewinder Speed strap
 - Carbon, Ø 13mm
 - mini race basket
 - tungsten/carbide tip

- art. # 139 23 09-48 green
- art. # 139 23 10-14 pink



SIDEWINDER Carbon

Sizes:
· 110-135cm (in 5cm steps)

- Features:**
- Pistol Airfoam grip
 - Sidewinder Speed strap
 - Carbon, Ø 13mm
 - mini UL bakset
 - flex carbide tip short

- art. # 146 23 55-10 black
- art. # 146 23 56-10 white



new Sidewinder strap system
easy and safe to use



SIDEWINDER Ti

Sizes:
· 110-135cm (in 5cm steps)

- Features:**
- Pistol Airfoam grip
 - Sidewinder Speed strap
 - Aluminum 5083, Ø 16mm
 - mini UL bakset
 - steel tip

- art. # 138 23 04-10 black
- art. # 138 23 05-10 white



RACING
BIG MOUNTAIN
JUNIOR
RENTAL
TOURING
SNOWSHOES
NORDIC XC
PROTECTION
TREKKING
NORDIC WALKING
ACCESSORIES

RACING
BIG MOUNTAIN
JUNIOR
RENTAL
TOURING
SNOWSHOES
NORDIC XC
PROTECTION
TREKKING
NORDIC WALKING
ACCESSORIES

RESORT CARBON

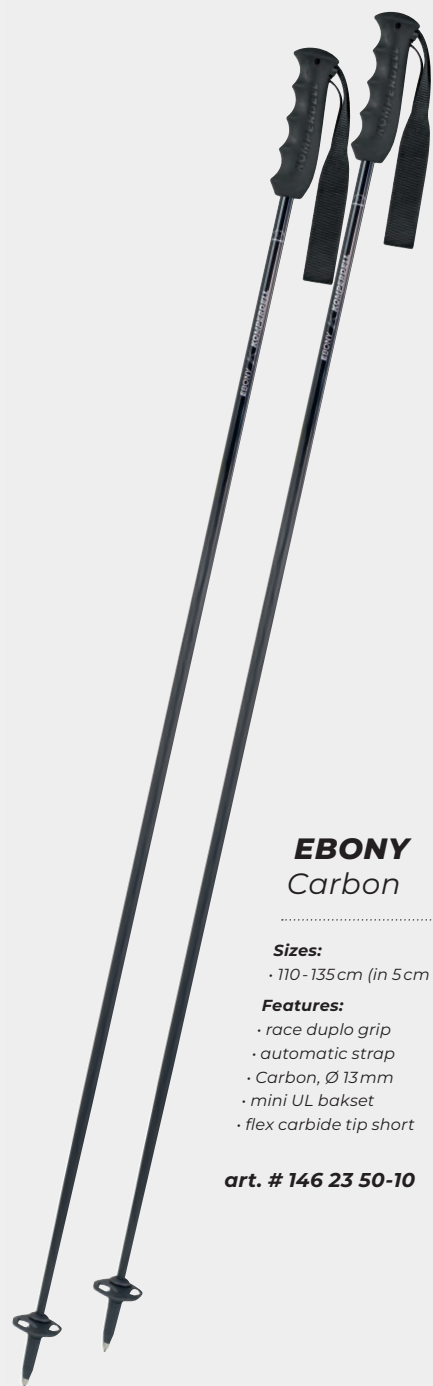

EBONY Carbon

Sizes:
· 110 - 135cm (in 5cm steps)

Features:
· race duplo grip
· automatic strap
· Carbon, Ø 13mm
· mini UL bakset
· flex carbide tip short

art. # 146 23 50-10

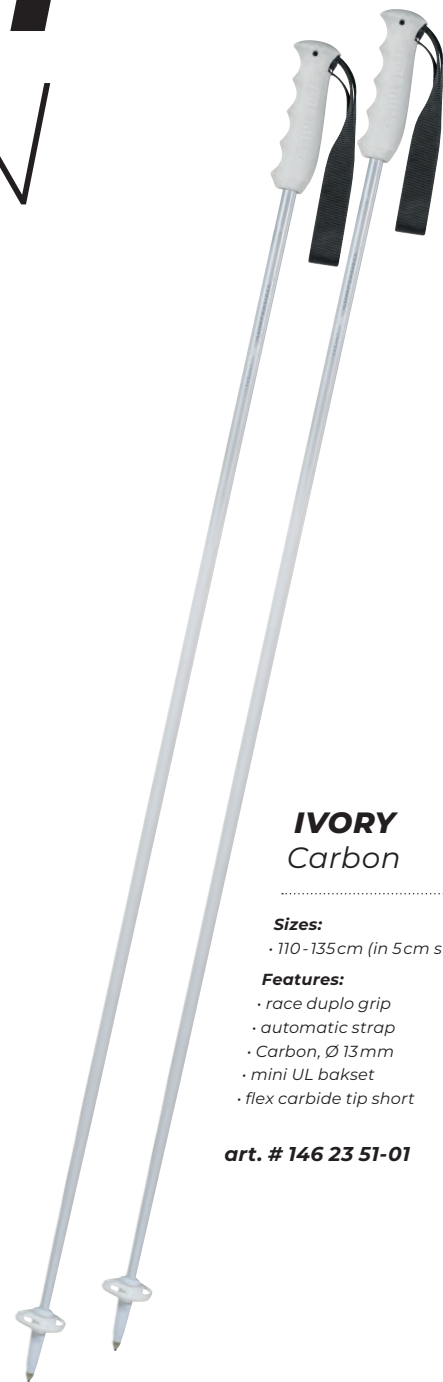

IVORY Carbon

Sizes:
· 110 - 135cm (in 5cm steps)

Features:
· race duplo grip
· automatic strap
· Carbon, Ø 13mm
· mini UL bakset
· flex carbide tip short

art. # 146 23 51-01



RESORT ALUMINUM



VICTORY TI

Sizes:
· 110 - 135cm (in 5cm steps)

Features:
· race grip rubber
· automatic strap
· Aluminum 5083, Ø 16mm
· mini UL bakset
· steel tip

■ art. # 138 23 02-12 midnight grey
□ art. # 138 23 03-01 bright white



VICTORY

Sizes:
· 110 - 135cm (in 5cm steps)

Features:
· PE race grip
· standard strap
· Aluminum 5083, Ø 16mm
· mini UL bakset
· steel tip

art. # 132 11 08-10



RESORT ALUMINUM



funnel to fill

ALPINE Schnapspole

Sizes:
· 110 - 135cm (in 5cm steps)

Weight:
· 327 g (125cm)

Features:
· inner tube for Schnaps including funnel
· volume: approx. 0,2l /pole
· PE-grip with inner tube
· standard strap
· Aluminum 7075, Ø19mm
· mini UL basket
· steel tip

art. # 144 93 03-02

RESORT BAMBOO



grip made of genuine leather

sheer bamboo veneer
wrapped around the Carbon shaft

Powerlock 3.0
highly rigid, anodized
Aluminum for maximum
holding power!

adjustable from
110 - 140 cm

CARBON Bamboo Vario

Sizes:
· adjustable from 110 - 140cm

Weight:
· 199g

Features:
· leather grip
· leather strap with embossed logo
· 2-sections:
 upper part: Carbon enhanced with bamboo, Ø16mm
 lower part: Carbon, Ø14mm
· Powerlock 3.0 mechanism
· regular UL vario basket
· vario flex carbide tip

art. # 175 22 15-10

CARBON Bamboo

Sizes:
· 110 - 135cm (in 5cm steps)

Weight:
· 163g (125cm)

Features:
· leather grip
· leather strap with embossed logo
· Carbon featherlight, Ø16mm
· enhanced with bamboo
· Mini UL basket
· flex carbide tip

art. # 148 22 20-10

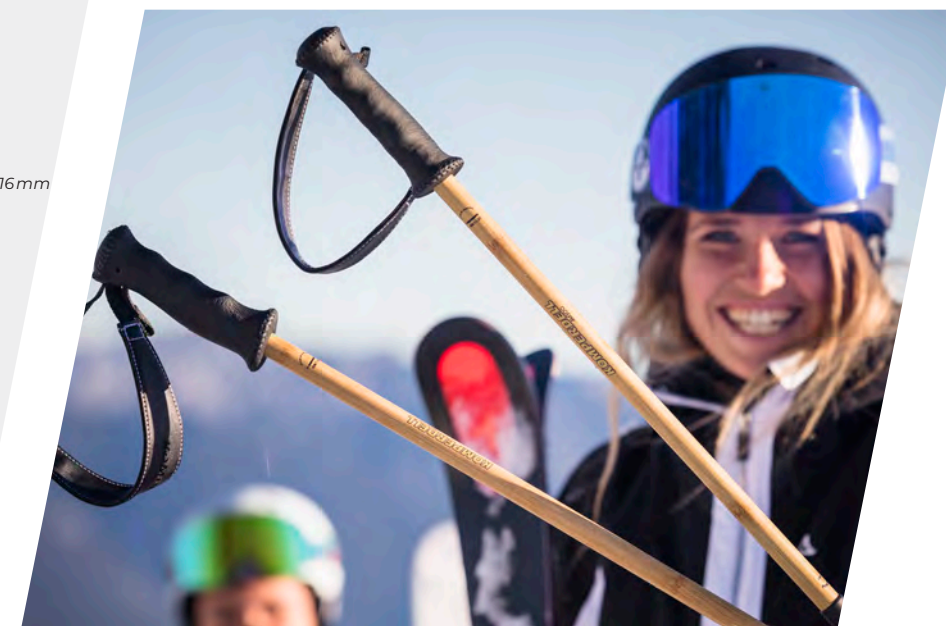



BIG Art SERIES



EXPERIENCE THE FUTURE OF FREERIDING

The freeride pole that turns heads - its robust 22,5mm shaft and lightweight design combined with customizable tapes create a truly unique look. Make a statement and draw new lines in the powder in your individual style.



Easy handling
Simply thread the ring over the handle head and off you go!



Uncoupling made easy
Pull the hand forwards over the grip head. Uncouple the ring with a short pull.

CHANGEABLE ART-TAPES
give your pole an individual touch. Simply tape on – done!

LIGHTWEIGHT AND ROBUST -
all shafts are made of finest carbon or aluminium-titanal

GRIP GEOMETRY
for Sidewinder strap system guarantees a rock-solid hold

SPECIAL GRIP SHAPE
to adjust conventional touring bindings

FEEL BIG, FEEL FREE -
with a full 22,5 mm shaft diameter



ISPO
AWARD
2024
WINNER



BIG ART SERIES

Our BigArt is the rockstar amongst freeride poles and will sure turn heads. Make a statement and customize the grip tapes and show your unique style!



STYLE YOUR POLE!

STYLE YOUR POLE!

STYLE YOUR POLE!

STYLE YOUR POLE!

RACING
BIG MOUNTAIN
JUNIOR
RENTAL
TOURING
SNOWSHOES
NORDIC XC
PROTECTION
TREKKING
NORDIC WALKING
ACCESSORIES

BIG Art CARBON



adjustable from 110 - 140 cm

BIG ART Carbon Team

- Sizes:**
- adjustable from 110 - 140 cm
- Features:**
- Fatso Tape 375 grip
 - Sidewinder Loop strap
 - 2-sections:
 - upper part: Carbon, Ø18mm
 - lower part: Carbon, Ø16mm
 - snowflake ice-flex basket
 - ice-flex carbide tip short

art. # 175 23 93-10
ISPO AWARD 2024 WINNER



adjustable from 110 - 140 cm

BIG ART Carbon Vario

- Sizes:**
- adjustable from 110 - 140 cm
- Features:**
- Fatso Tape 375 grip
 - Sidewinder Loop strap
 - 2-sections:
 - upper part: Carbon, Ø18mm
 - lower part: Carbon, Ø16mm
 - snowflake ice-flex basket
 - ice-flex carbide tip short

- art. # 175 23 94-10 full colour neongreen
- art. # 175 23 95-10 full colour neonpink

ISPO AWARD 2024 WINNER

+ ADDITIONALLY AVAILABLE



SIDEWINDER LOOP STRAP

art. # 7040-02



SIDEWINDER SPORT STRAP

art. # 7029-2k1

RACING
BIG MOUNTAIN
JUNIOR
RENTAL
TOURING
SNOWSHOES
NORDIC XC
PROTECTION
TREKKING
NORDIC WALKING
ACCESSORIES

BIG Art ALUMINUM



BIG ART Telescopic Lot Box

- Features:**
- 59x38.5x68 cm (measured without sticks)
 - In-store display for 25 pairs Telescopic poles
 - made of robust cardboard
 - ideal for every shop

art. # 6705-999

TAPE BOX Big Art

- Features:**
- box for 20 pairs of tapes

art. # 6708-999



STYLE YOUR POLE! STYLE YOUR POLE! STYLE YOUR POLE!



BIG ART Titanal Vario

- Sizes:**
- adjustable from 110 – 140 cm

- Features:**
- Fatso Tape 375 grip
 - Sidewinder Loop strap
 - 2-sections: upper part: Aluminum 7075, Ø18mm lower part: Aluminum 7075, Ø16mm
 - snowflake ice-basket
 - ice-flex carbide tip short

■ art. # 184 24 42-10 stripe black/neongreen

■ art. # 184 24 41-10 stripe black/neonpink

ISPO AWARD 2024 WINNER

REPLACEABLE GRIP TAPES
STYLISH BIG ART LOOK

adjustable from 110 – 140 cm

adjustable from 100 – 125 cm

BIG ART Junior Vario

- Sizes:**
- adjustable from 100 – 125 cm

- Features:**
- Fatso Tape 375 grip
 - Sidewinder Loop strap
 - 2-sections: upper part: Aluminum 7075, Ø18mm lower part: Aluminum 7075, Ø16mm
 - snowflake ice-basket
 - ice-flex carbide tip short

art. # 164 23 22-10

ISPO AWARD 2024 WINNER

+ ADDITIONALLY AVAILABLE



SIDEWINDER LOOP STRAP

art. # 7040-02



SIDEWINDER SPORT STRAP

art. # 7029-2k1

BIG Art CARBON/TI



BRAND NEW

BIG ART Fixed Length Lot Box

- Features:**
- 59x38.5x68 cm (measured without sticks)
 - In-store display for 25 pairs fixed length poles
 - made of robust cardboard
 - ideal for every shop

art. # 6706-999

TAPE BOX Big Art

- Features:**
- box for 20 pairs of tapes
- art. # 6708-999



BRAND NEW

STYLE YOUR POLE!
STYLE YOUR POLE!
STYLE YOUR POLE!
STYLE YOUR POLE!



STYLE YOUR POLE!

BRAND NEW

REPLACEABLE GRIP TAPES
STYLISH BIG ART LOOK



BRAND NEW

BIG ART Fat Carbon

- Sizes:**
- 110 - 135 cm (in 5 cm steps)
- Features:**
- Fatso Tape 375 stripe black/gold grip
 - Sidewinder Loop strap
 - Carbon, Ø 22,5mm
 - snowflake ice-flex basket
 - ice-flex carbide tip short

art. # 145 23 01-10
ISPO AWARD 2024 WINNER

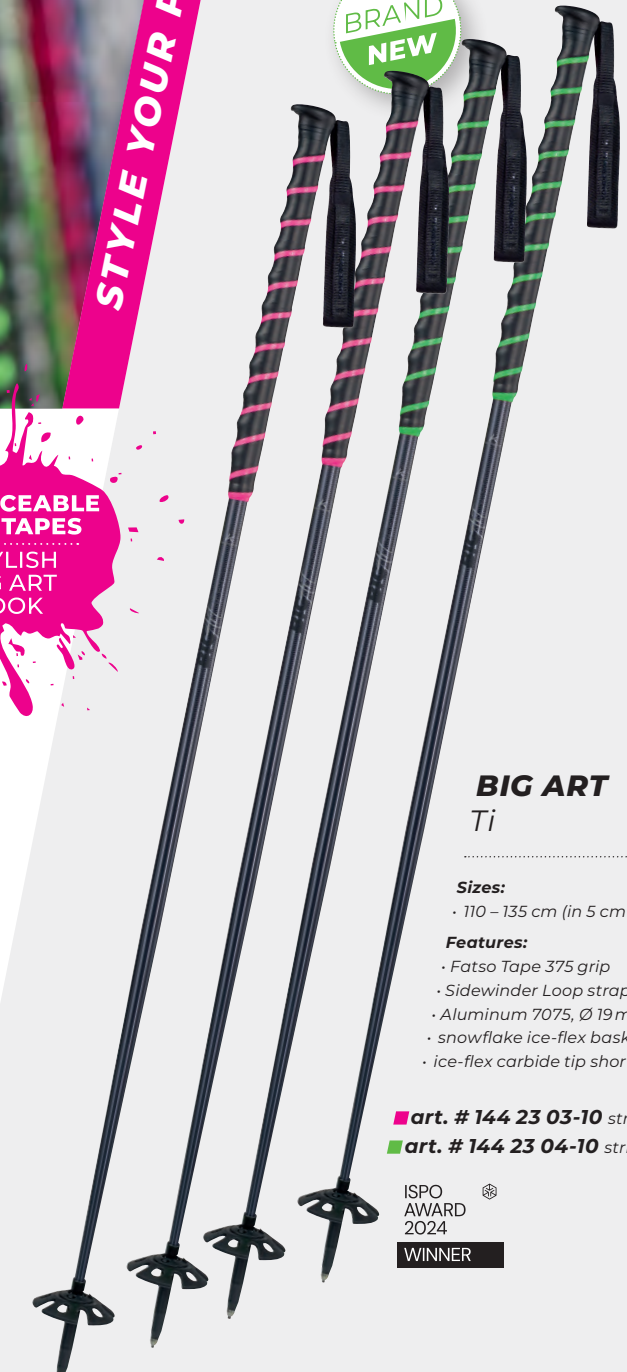

BIG ART Ti

- Sizes:**
- 110 - 135 cm (in 5 cm steps)
- Features:**
- Fatso Tape 375 grip
 - Sidewinder Loop strap
 - Aluminum 7075, Ø 19 mm
 - snowflake ice-flex basket
 - ice-flex carbide tip short

art. # 144 23 03-10 stripe black/neonpink
art. # 144 23 04-10 stripe black/neongreen
ISPO AWARD 2024 WINNER

ADDITIONALLY AVAILABLE



SIDEWINDER LOOP STRAP
art. # 7040-02



SIDEWINDER SPORT STRAP
art. # 7029-2k1

BIG ART SERIES

Make a statement and customize your pole to your style!

The new ART-TAPES come in many stylish colours and offer superior grip, even in wet or snowy conditions.

Draw new lines in the powder and leave your own signature.

Just wrap the tape – ready to go!

The Big Art Tapes fit to all poles of the Big Art Series.

STYLE YOUR POLE - CHANGE YOUR TAPE

CREATE YOUR OWN LOOK!

1. Wrap the new overgrip tape from bottom to top with a small overlap. The basic tape does not have to be replaced.
2. Wrap the tape until the griphead.
3. Cut the tape with a knife along the lower edge of the grip head.
4. Fix the tape with the provided black duck tape.

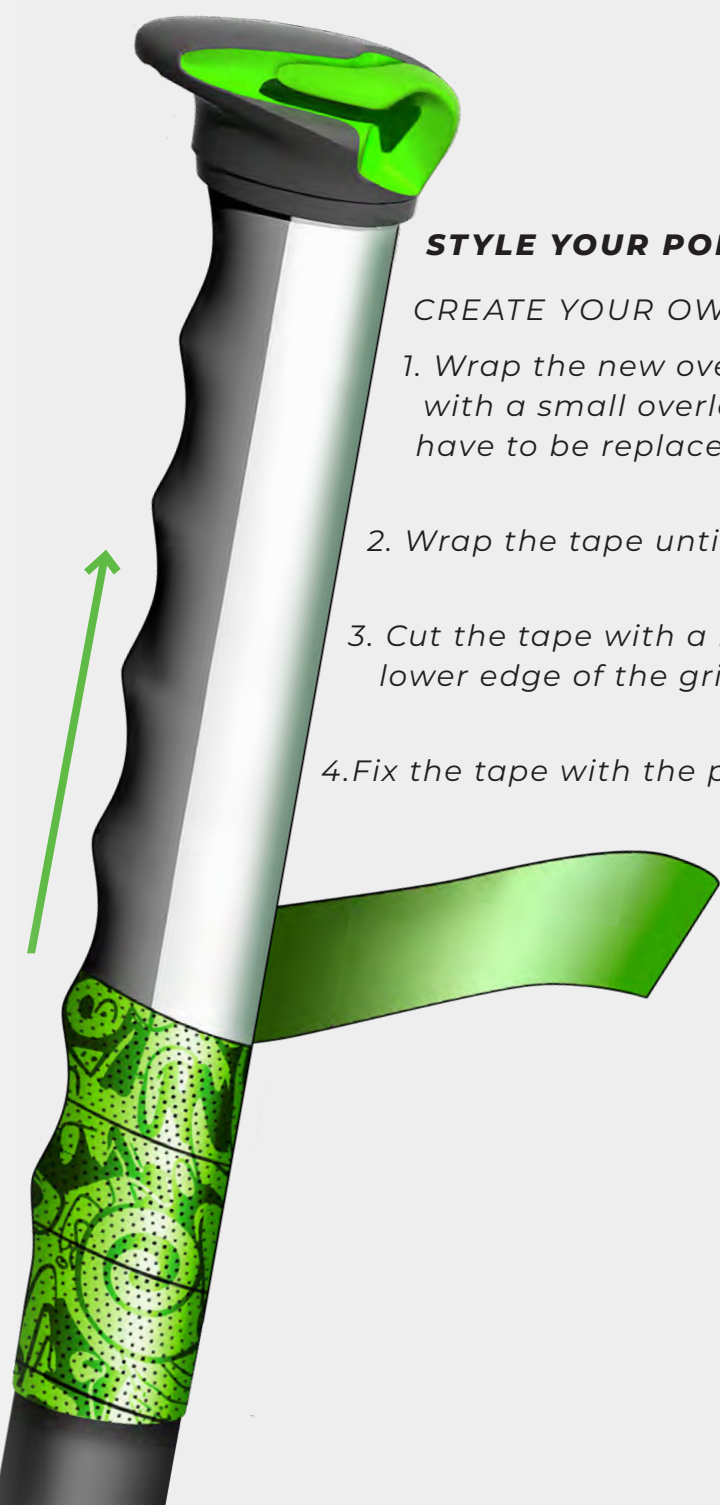

STYLE YOUR POLE!

STYLE YOUR POLE!

STYLE YOUR POLE!

STYLE YOUR POLE!

BIG Art TAPES

REPLACEABLE
GRIP TAPES
STYLISH
BIG ART
LOOK



Tape Doodle 35mm

- art. # 8270-48 Doodle neon green
- art. # 8270-14 Doodle neon pink
- art. # 8270-999 Doodle multicolor



Tape Full Colour 35mm

- art. # 8278-14 Full Colour pink
- art. # 8278-48 Full Colour green
- art. # 8278-02 Full Colour black



Tape Cheetah 35mm

- art. # 8279-02 Cheetah black/black
- art. # 8279-209 Cheetah black/pink
- art. # 8279-14 Cheetah pink/magenta
- art. # 8279-242 Cheetah gold/black



Tape Stripe 35mm

- art. # 8277-213 Stripe black/green
- art. # 8277-209 Stripe black/green
- art. # 8277-242 Stripe black/gold



Tape Sprayed 35mm

- art. # 8275-213 Sprayed neon green/black
- art. # 8275-209 Sprayed neon pink/black
- art. # 8275-02 Sprayed black/black
- art. # 8275-211 Sprayed black/white
- art. # 8275-207 Sprayed black/blue

BIG Art ALL MOUNTAIN



BIG CAT Pink/Black

Sizes:
· 110 – 135 cm (in 5 cm steps)

- Features:**
- Pistol Airfoam grip
 - Sidewinder Loop strap
 - Aluminum 7075, Ø 18 mm
 - snowflake vario basket
 - vario flex carbide tip

art. # 134 23 25-10

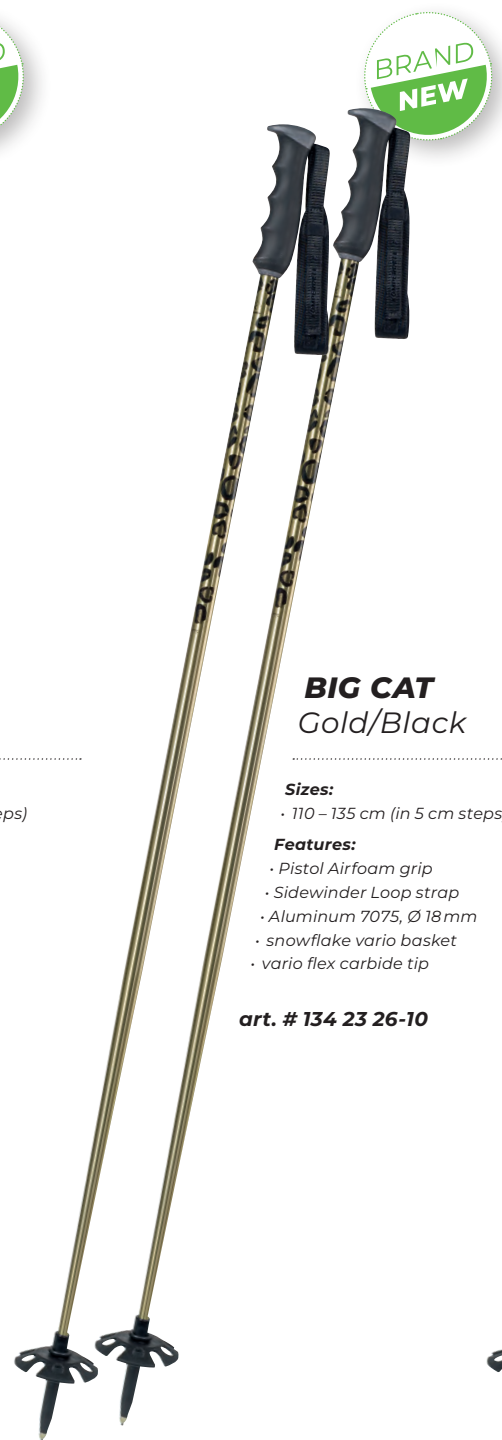

BIG CAT Gold/Black

Sizes:
· 110 – 135 cm (in 5 cm steps)

- Features:**
- Pistol Airfoam grip
 - Sidewinder Loop strap
 - Aluminum 7075, Ø 18 mm
 - snowflake vario basket
 - vario flex carbide tip

art. # 134 23 26-10



BIG CAT Smoke Grey/Black

Sizes:
· 110 – 135 cm (in 5 cm steps)

- Features:**
- Pistol Airfoam grip
 - Sidewinder Loop strap
 - Aluminum 7075, Ø 18 mm
 - snowflake vario basket
 - vario flex carbide tip

art. # 134 23 24-10



SPRAYED Dark Navy/Pink

Sizes:
· 110 – 135 cm (in 5 cm steps)

- Features:**
- Pistol Airfoam grip
 - Sidewinder Loop strap
 - Aluminum 7075, Ø 18 mm
 - snowflake vario basket
 - vario flex carbide tip

art. # 134 23 27-10



SPRAYED Black/White

Sizes:
· 110 – 135 cm (in 5 cm steps)

- Features:**
- Pistol Airfoam grip
 - Sidewinder Loop strap
 - Aluminum 7075, Ø 18 mm
 - snowflake vario basket
 - vario flex carbide tip

art. # 134 23 28-10



SPRAYED White/Black

Sizes:
· 110 – 135 cm (in 5 cm steps)

- Features:**
- Pistol Airfoam grip
 - Sidewinder Loop strap
 - Aluminum 7075, Ø 18 mm
 - snowflake vario basket
 - vario flex carbide tip

art. # 134 23 29-10

ALPINE JUNIOR VARIO



FULLY ADJUSTABLE 80 – 105 CM

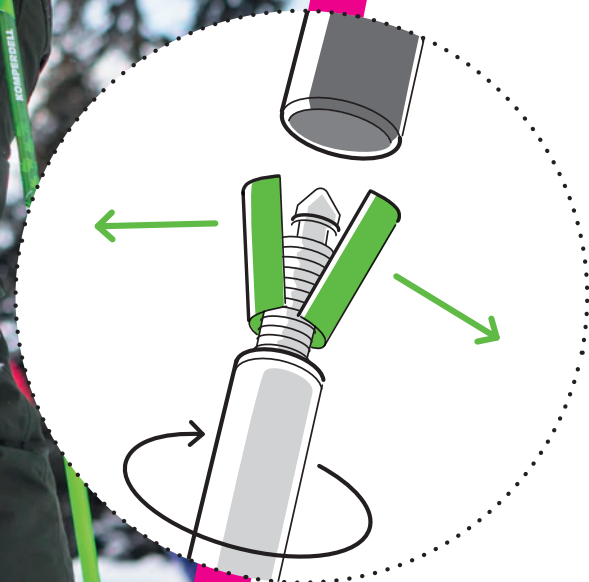

The pole, that grows with your kid!
Thanks to our simple and million times proven length adjustment with twist lock, the length of the pole can be easily adapted to the growing height of the child.



SMASH SERIES

Sizes:
· adjustable from 80-105cm

Features:
· PU grip junior
· standard strap
· Twist Lock system
· 2-sections:
Aluminum 7075, Ø16/14mm
· racing basket vario
· steel tip

■ art. # 164 32 01-48 green

■ art. # 164 32 03-14 pink

■ art. # 164 32 05-04 blue

LOT BOX SMASH JUNIOR

Features:
· 59 x 86 x 36 cm (measured without poles)
· Instore display for 25 pairs of Smash Series poles
· made of cardboard
· perfect for every shop

art. # 61-999



ALPINE JUNIOR



BRAND NEW

CHAMP GREEN Junior

Sizes:
· 70-105cm (in 5cm steps)

- Features:**
- race grip junior
 - standard stap
 - Aluminum 5083, Ø14mm
 - mini race basket
 - steel tip

art. # 211 23 11-48

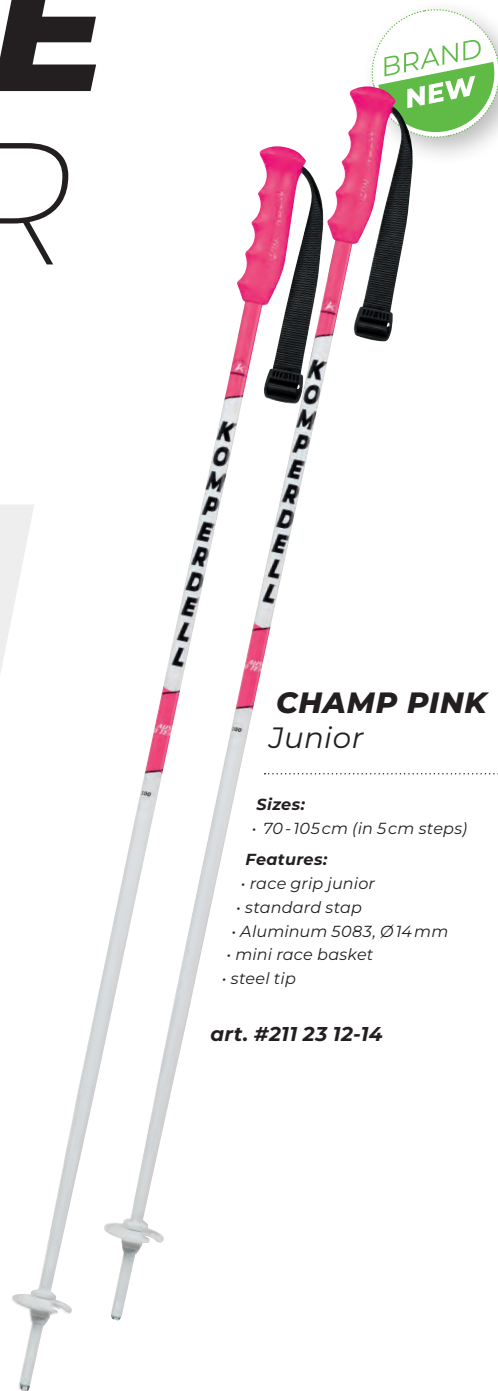

BRAND NEW

CHAMP PINK Junior

Sizes:
· 70-105cm (in 5cm steps)

- Features:**
- race grip junior
 - standard stap
 - Aluminum 5083, Ø14mm
 - mini race basket
 - steel tip

art. #211 23 12-14



BRIGHT YELLOW

Sizes:
· 70-105cm (in 5cm steps)

- Features:**
- race grip junior
 - junior strap
 - Aluminum 5083, Ø14mm
 - mini race basket
 - steel tip

art. # 211 33 05-15

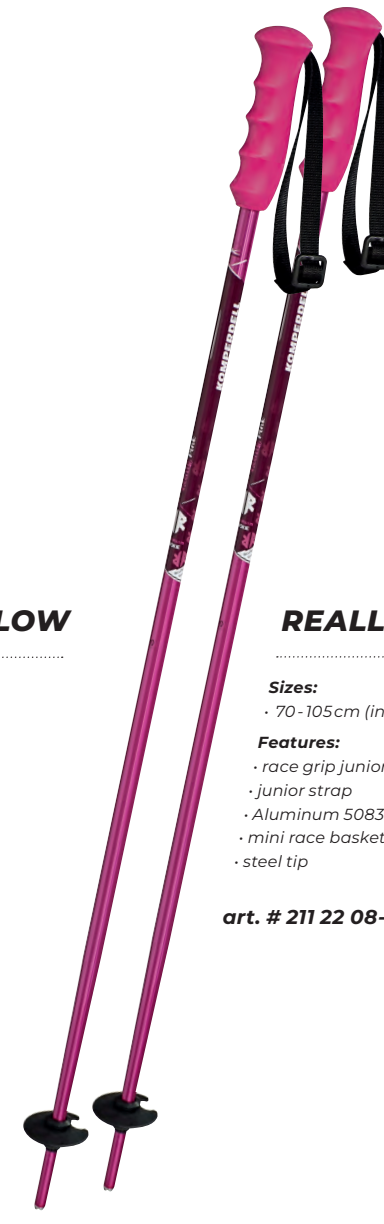

REALLY PINK

Sizes:
· 70-105cm (in 5cm steps)

- Features:**
- race grip junior
 - junior strap
 - Aluminum 5083, Ø14mm
 - mini race basket
 - steel tip

art. # 211 22 08-28

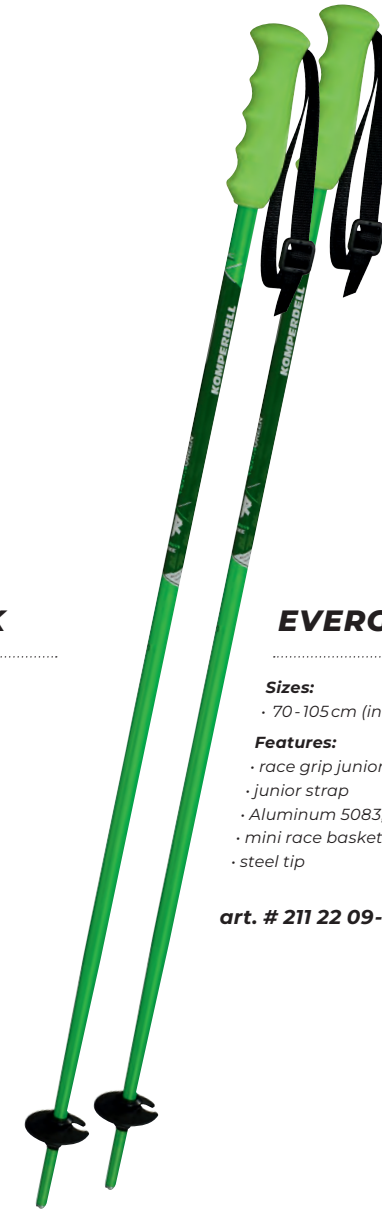

EVERGREEN

Sizes:
· 70-105cm (in 5cm steps)

- Features:**
- race grip junior
 - junior strap
 - Aluminum 5083, Ø14mm
 - mini race basket
 - steel tip

art. # 211 22 09-48

ALPINE JUNIOR



KIDS SKI-SET

Sizes:
· 60cm
· 70cm

Features:
· skiset for beginners
· available in two lengths

■ **art. # 201-115** Spike Boys

■ **art. # 201-116** Lucy Girls



← **the set for beginners**
perfect for those first attempts
at skiing



BLUE BOOST

Sizes:
· 70-105cm (in 5cm steps)

Features:
· race grip junior
· junior strap
· Aluminum 5083, Ø14mm
· mini race basket
· steel tip

art. # 211 22 10-04

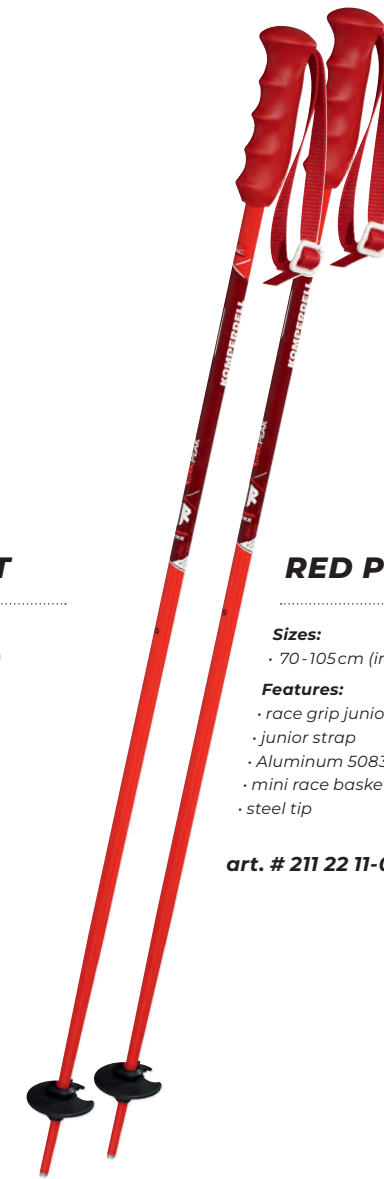

RED PEAK

Sizes:
· 70-105cm (in 5cm steps)

Features:
· race grip junior
· junior strap
· Aluminum 5083, Ø14mm
· mini race basket
· steel tip

art. # 211 22 11-03



CHALLENGER

Sizes:
· 70-105cm (in 5cm steps)

Features:
· junior jet grip
· junior strap
· Aluminum 5083, Ø14mm
· mini race basket
· steel tip

art. # 211 11 03-10

RENTAL ALPINE

Benefit from our 2-year breakage warranty on our high-quality carbon rental poles. Your rental customers will appreciate the lightweight, durable design of our alpine poles.



examples of individual prints

+ INDIVIDUAL AND FLEXIBLE

- + Starting from a small order quantity, we offer you individual customization of poles, protectors, or snowshoes with your own designs.
- + We offer a 2-season breakage warranty on all carbon and telescopic poles because we are absolutely convinced of the quality of our products. Unique and only from Komperdell!

RENTAL ALPINE



RENTAL CARBON Adult / Junior

Sizes:

- Adult: 110 - 135 cm (in 5cm steps)
- Junior: 80 - 105 cm (in 5cm steps)

Features:

- Race PU / Race PU junior
- system strap XL / standard strap
- carbon, Ø 13mm
- mini race basket
- flex steel tip

art. # 146 22 20-10 adult
art. # 146 22 21-10 junior



RENTAL SOFT CLEAR THERMO Adult / Junior

Sizes:

- Adult: 110 - 135 cm (in 5cm steps)
- Junior: 70 - 105 cm (in 5cm steps)

Features:

- Race grip transparent matt
- system strap XL / Junior strap
- Alu 7075-T6, Ø 19mm / Alu 5083, Ø 16mm
- mini race basket
- flex steel tip

art. # 144 23 10-10 adult
art. # 221 23 10-10 junior

colour code system for quick length identification of all rental poles in the store (lengths in cm)



RENTAL ALPINE

Full range adjustable rental poles mean less stock and never running out of sizes. All this backed by our 2-season breakage guarantee.



+ INDIVIDUAL AND FLEXIBLE

+ Starting from a small order quantity, we offer you individual customization of poles, protectors, or snowshoes with your own designs.

+ We offer a 2-season breakage warranty on all carbon and telescopic poles because we are absolutely convinced of the quality of our products. Unique and only from Komperdell!

RENTAL ALPINE

Individual prints
We can personalize sticks from just 200 pairs and provide them with individual logo prints.

2 years Breakage guarantee
for all carbon and telescopic poles

2 SEASONS BREAKAGE GUARANTEE

adjustable from 110 - 140 cm

RENTAL VARIO Carbon

Sizes:
• adjustable from 110-140 cm

Features:
• Race PU
• Comfort strap
• 2-sections:
Upper part: Titanal, Ø 18 mm
Lower part: Carbon, Ø 16 mm
• Powerlock 3.0 mechanism
• Regular UL Basket
• Flex steel tip

art. # 184 24 49-10

Powerlock 3.0
highly rigid, anodized aluminum for maximum holding power!

Adult:
adjustable from 110-140 cm

Junior:
adjustable from 80-105 cm

RENTAL VARIO TI Adult / Junior

Sizes:
• Adult: adjustable from 110-140 cm
• Junior: adjustable from 80-105 cm

Features:
• Race grip transparent matt
• Standard strap
• 2-sections:
Upper part: Titanal, Ø 18 mm / Titanal, Ø 16 mm
Lower part: Aluminum 7075-T6, Ø 16 mm / Aluminum 5083, Ø 14 mm
• Powerlock 3.0 mechanism / Twist Lock
• Regular UL Basket / Mini UL Basket
• Flex steel tip / steel tip

art. # 184 24 43-10 adult
art. # 164 23 23-10 junior



RENTAL NORDIC

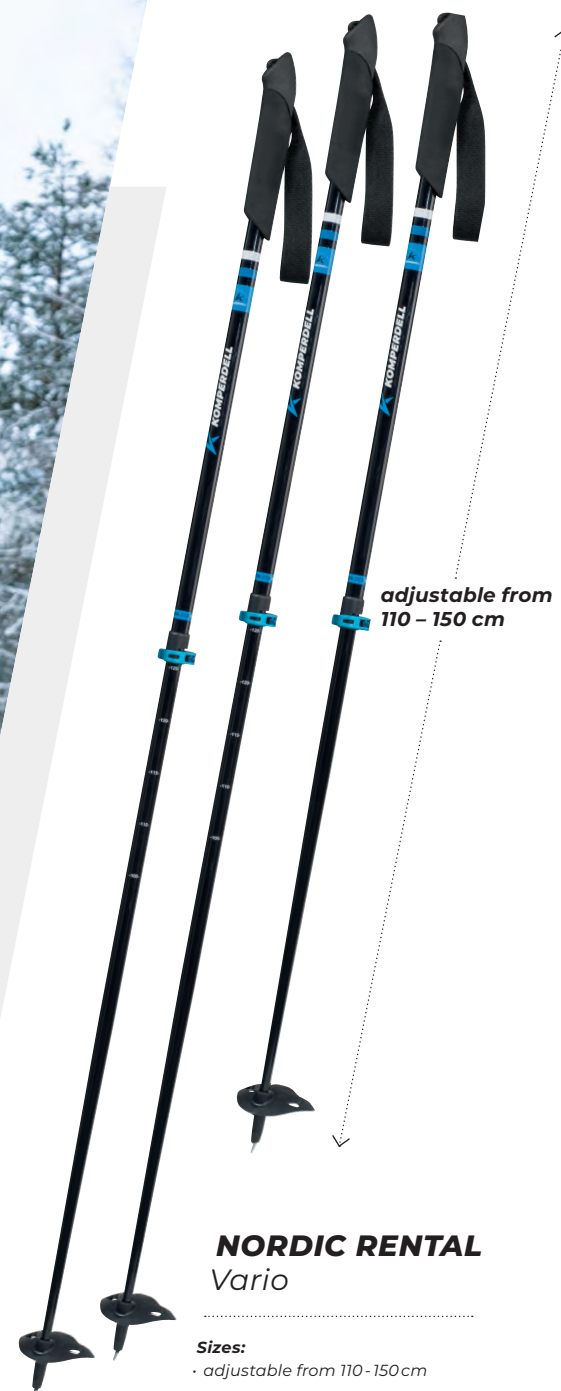

NORDIC RENTAL Vario

- Sizes:**
- adjustable from 110 - 150 cm
- Weight:**
- 229 g
- Features:**
- Nordic Foam grip
 - padded Nordic strap
 - 2-sections: Titanal .HF 7075-T6, Ø 18/16 mm
 - Powerlock 3.0 mechanism
 - BC Nordic basket
 - Nordic steel tip

art. # 184 23 01-10

RENTAL TOURING



RENTAL TOUR Carbon

- Sizes:**
- adjustable from 105 - 140 cm
- Weight:**
- 190 g
- Features:**
- Contour Foam grip
 - System strap
 - 2-sections:
 - Upper part: Aluminum, Ø 16 mm
 - Lower part: Carbon, Ø 14 mm
 - Large UL vario basket
 - Flex Tungsten/Carbide tip

art. # 184 23 02-10

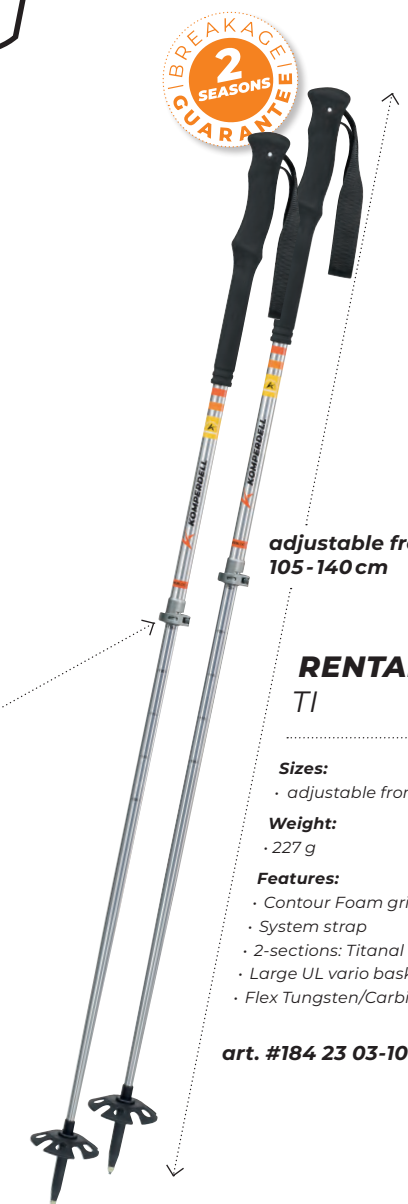

adjustable from
105 - 140 cm

RENTAL TOUR Ti

- Sizes:**
- adjustable from 105 - 140 cm
- Weight:**
- 227 g
- Features:**
- Contour Foam grip
 - System strap
 - 2-sections: Titanal 7075-T6, Ø 18/16 mm
 - Large UL vario basket
 - Flex Tungsten/Carbide tip

art. #184 23 03-10



PROTECTOR PACK

RACING
BIG MOUNTAIN
JUNIOR
RENTAL
TOURING
SNOWSHOES
NORDIC XC
PROTECTION
TREKKING
NORDIC WALKING
ACCESSORIES



removable strap system
eliminates pressure points

top residual force values

Height-adjustable kidney belt
for perfect fit

multi impact capable

PROTECTOR PACK Men

Sizes:
· XXS-XL

- Features:**
- multilayer Cross Flex back-protector made of adaptive dual-density foam, EN-approved 1621-2, level 2
 - confirms to FIS regulations
 - anatomic shaped back for best fit
 - new detachable strap system – shoulder it like a backpack
 - protector insert visible - part of the design concept
 - ultimate freedom of movement
 - height-adjustable kidney belt for perfect fit, adjustable with velcro and plush

art. # 6696-2



BRAND NEW



removable strap system
eliminates pressure points

top residual force values

Height-adjustable kidney belt
for perfect fit

multi impact capable

PROTECTOR PACK Junior

Sizes:
· 128-152

- Features:**
- multilayer Cross Flex back-protector made of adaptive dual-density foam, EN-approved 1621-2, level 2
 - confirms to FIS regulations
 - anatomic shaped back for best fit
 - new detachable strap system – shoulder it like a backpack
 - protector insert visible - part of the design concept
 - ultimate freedom of movement
 - height-adjustable kidney belt for perfect fit, adjustable with velcro and plush

art. # 6697-2



meets FIS regulations

removable strap system
eliminates pressure points

Height-adjustable kidney belt
for perfect fit



RACING
BIG MOUNTAIN
JUNIOR
RENTAL
TOURING
SNOWSHOES
NORDIC XC
PROTECTION
TREKKING
NORDIC WALKING
ACCESSORIES

RENTAL SNOWSHOES

The high performance aluminum frame and Hypalon decking create durable, yet lightweight snowshoes.

**QUICKLOCK BINDING**

super easy to adjust, fitting all sizes and types of boots and offering perfect hold

**OPTIONAL****Snowshoe Toe Cover S-M-L**

- keeps your feet dry and warm
- easy attachment to the binding by push button system

art. # 6574-925

Quicklock**Snowshoe Binding M-L**

- separate Quicklock Binding with lacing system
- suitable for common outdoor shoes
- optimal, comfortable fitting

art. # 6643-925

**PEAKMASTER Snowshoe 30****Size & load capacity:**

- T30 - bis 120 kg (baggage included)
- Binding L

Weight:

- T30 - 975 g/piece

Features:

- anodized High-Performance Aluminum Frame
- durable Hypalon decking
- Steel Front claw and middle claw for traction in different conditions
- Heel Lift
- Easy Step-In Binding in 3 sizes available

art. # 6576-10 T30 red

ALUMINUM SNOWSHOES

**PEAKMASTER Snowshoe 25****Size & load capacity:**

- T25 - bis 100 kg (baggage included)
- Binding M

Weight:

- T25 - 905 g/piece

Features:

- anodized High-Performance Aluminum Frame
- durable Hypalon decking
- Steel Front claw and middle claw for traction in different conditions
- Heel Lift
- Easy Step-In Binding in 3 sizes available

art. # 6577-10 T25 blue

**PEAKMASTER Snowshoe 22****Size & load capacity:**

- T22 - bis 80 kg (baggage included)
- Binding S

Weight:

- T22 - 833 g/piece

Features:

- anodized High-Performance Aluminum Frame
- durable Hypalon decking
- Steel Front claw and middle claw for traction in different conditions
- Heel Lift
- Easy Step-In Binding in 3 sizes available

art. # 6578-10 T22 ribes



POWER LOCK 3.0

THE STRONGEST LOCK ON THE MARKET

"The strongest lock and best reliability I have ever seen in a locking mechanism. An indispensable companion especially in demanding terrain – simply outstanding technology from Komperdell."

Gerlinde Kaltenbrunner, professional mountaineer

100% ALUMINUM
both the clamp and the fastener
are made of 100% forged aluminum

THE STRONGEST LOCK
with holding power up to 200kg

**SUPERIOR
CLAMPING FORCE**
without readjusting

HIGHEST PRESSURE LOAD
in test comparisons

**NO LOSS OF
HOLDING POWER**
under conditions of increased
humidity, cold, or heat

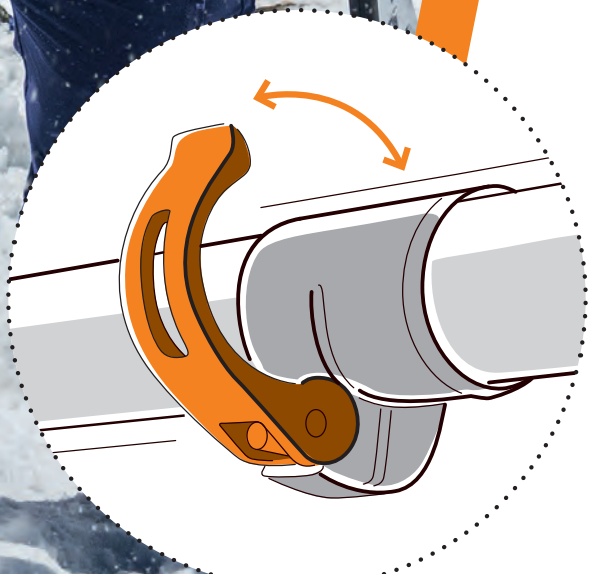

Easy handling
of the locking lever guarantees rapid
adjustability in extreme situations.



C2 ULTRALIGHT

We are the expert for carbon poles. We are the only brand developing, designing and manufacturing our shafts in our own facilities. On average, our poles are up to 25 % lighter than comparative poles on the market.



the lightest touring pole –
188 g only



TOURING CARBON

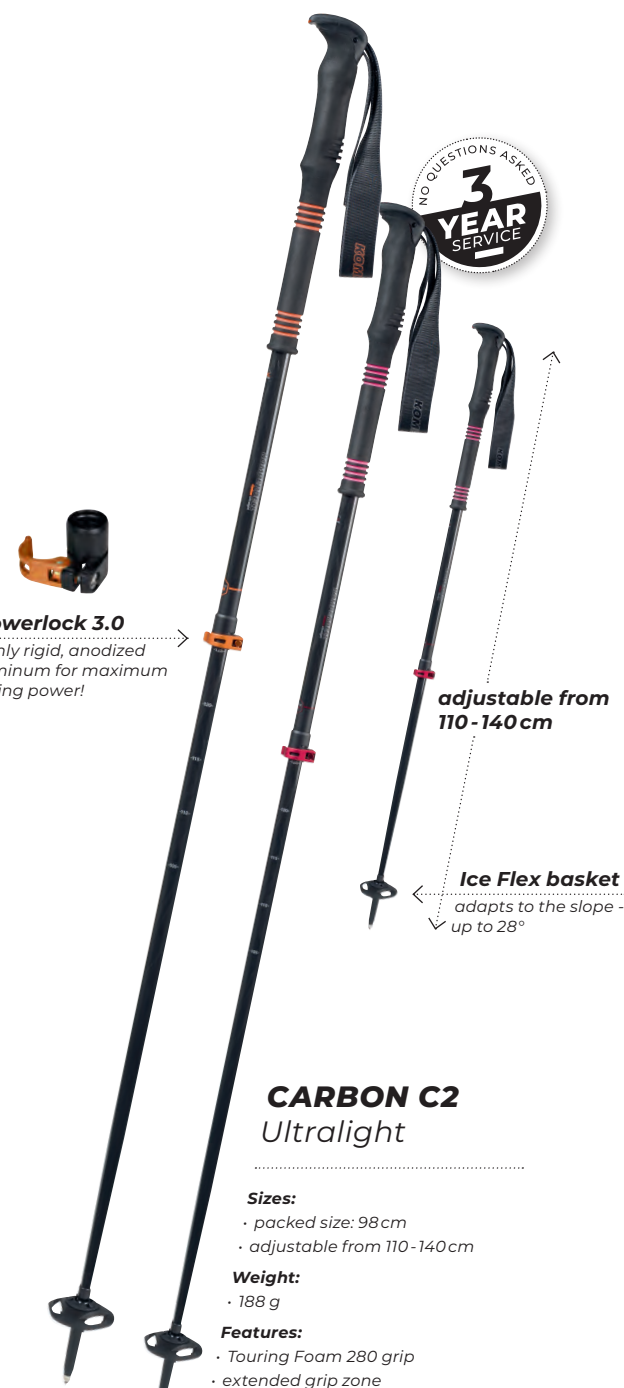

Powerlock 3.0
highly rigid, anodized
aluminum for maximum
holding power!

NO QUESTIONS ASKED
3
YEAR
SERVICE

adjustable from
110 - 140 cm

Ice Flex basket
adapts to the slope -
up to 28°

CARBON C2 Ultralight

Sizes:
· packed size: 98 cm
· adjustable from 110-140 cm

Weight:
· 188 g

Features:
· Touring Foam 280 grip
· extended grip zone
· Comfort Padded strap
· 2-sections:
upper part: Carbon ultralight, Ø 16mm
lower part: Carbon Composite, Ø 14mm
· Powerlock 3.0 mechanism
· large UL ice-flex basket
· ice-flex tungsten/carbide tip

art. # 175 23 75-10 orange

art. # 175 23 76-10 berry

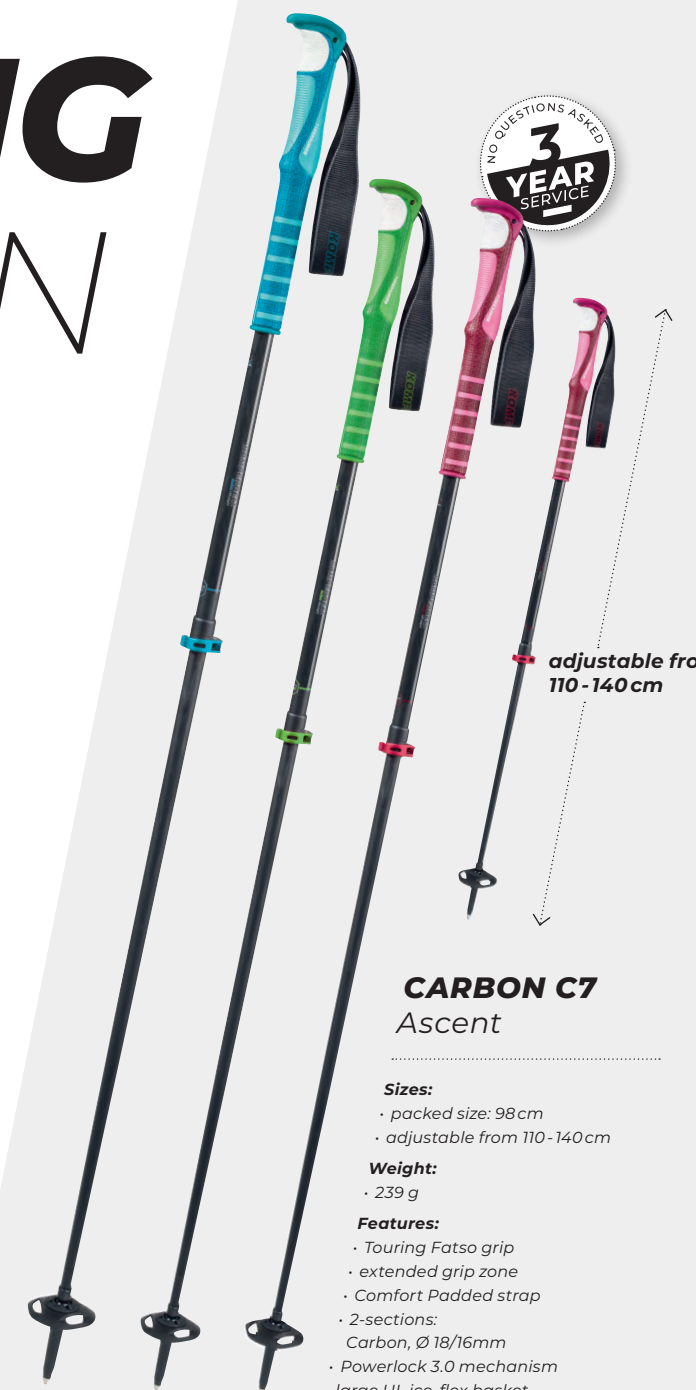

NO QUESTIONS ASKED
3
YEAR
SERVICE

adjustable from
110 - 140 cm

CARBON C7 Ascent

Sizes:
· packed size: 98 cm
· adjustable from 110-140 cm

Weight:
· 239 g

Features:
· Touring Fatso grip
· extended grip zone
· Comfort Padded strap
· 2-sections:
Carbon, Ø 18/16mm
· Powerlock 3.0 mechanism
· large UL ice-flex basket
· ice-flex tungsten/carbide tip

art. # 175 23 77-10 green

art. # 175 23 78-10 blue

art. # 175 23 79-10 berry



CONTOUR TITANAL

The ultra-light and almost indestructible pioneer among touring and backcountry poles has been part of our range for 20 years. Constantly improved, it is still the pole of choice for the truly passionate mountaineer.



adjustable from
105-140 cm

CONTOUR TITANAL II Foam

Sizes:
· packed size: 85 cm
· adjustable from 105-140 cm

Weight:
· 230 g

Features:
· Touring Foam 450 grip
· extra long grip zone
· Comfort Padded strap
· 2-sections:
Titanal.HF, Ø 16/14 mm
· Powerlock 3.0 mechanism
· large UL Vario basket
· vario tungsten/carbide flex tip

art. # 188 23 05-10



adjustable from
105-140 cm

CONTOUR TITANAL II Foam Pink

Sizes:
· packed size: 85 cm
· adjustable from 105-140 cm

Weight:
· 230 g

Features:
· Touring Foam 450 grip
· extra long grip zone
· Comfort Padded strap
· 2-sections:
Titanal.HF, Ø 16/14 mm
· Powerlock 3.0 mechanism
· large UL Vario basket
· vario tungsten/carbide flex tip

art. # 188 23 06-10



TOURING

TI



adjustable from
100-130 cm

FREE TOURING Junior

Sizes:
· packed size: 94 cm
· adjustable from 100-130 cm

Weight:
· 225 g

Features:
· Touring Foam Camo 280 grip
· extended grip zone
· Comfort Padded strap
· 2-sections:
Aluminum 7075-T6, Ø 18/16 mm
· Powerlock 3.0 mechanism
· regular UL Vario basket
· vario tungsten/carbide flex tip

art. # 164 23 15-10



adjustable from
110 - 140 cm

FREE TOURING TI

Sizes:
· packed size: 98 cm
· adjustable from 110 - 140 cm

Weight:
· 239 g

Features:
· Touring Foam 280 grip
· extended grip zone
· Comfort Padded strap
· 2-sections:
upper part: Aluminum 7075-T6, Ø 18 mm
lower part: Titanal Ti-7 Ø 16 mm
· Powerlock 3.0 mechanism
· large UL ice-flex basket
· ice-flex tungsten/carbide tip

art. # 184 23 81-02



FREERIDE VARIO

Designed for freeriders and backcountry skiing.
Rock your off-road ride with Komperdell D'scent.

Tool grip

PH and PZ screwdrivers are integrated into the removable grip for easy adjustment of bindings etc.

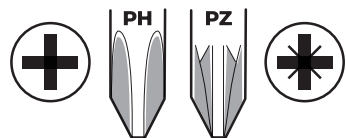

adjustable from
110-140cm

D'SCENT Backcountry Toolgrip Vario

Sizes:
• packed size: 97 cm
• adjustable from 110-140cm

Features:
• 2K Touring comfort grip
• BC Tool grip
• extended thermo grip zone
• Comfort Padded strap
• 2-sections:
 upper part: Aluminum 7075-T6 Titanal, Ø18mm
 lower part: Aluminum 7075-T6 Titanal, Ø16mm
• Powerlock 3.0 mechanism
• XL ice-flex basket
• ice-flex tungsten carbide-tip

art. # 184 24 36-12



adjustable from
110-140 cm

FREE TOURING Thermo Adventure

Sizes:
• packed size: 100 cm
• adjustable from 110-140 cm

Features:
• EVA foam grip
• extended Thermo grip zone
• system strap XL
• 2-sections:
 upper part: Aluminum 7075-T6, Ø 18mm
 lower part: Titanal Ti 7, Ø 16 mm
• Powerlock 3.0 mechanism
• large UL Vario basket
• vario tungsten/carbide flex tip

art. # 184 24 44-10



adjustable from
115-150 cm

T2 THERMO Adventure

Sizes:
• packed size: 85 cm
• adjustable from 115-150 cm

Features:
• EVA foam grip
• extended Thermo grip zone
• system strap XL
• 2-sections:
 Aluminum 7075-T6, Ø 18/16mm
• Powerlock 3.0 mechanism
• vario winter basket
• vario tungsten/carbide flex tip

art. # 184 24 45-10

SPEED TOURING



RACING | BIG MOUNTAIN | JUNIOR | RENTAL | TOURING | SNOWSHOES | NORDIC XC | PROTECTION | TREKKING | NORDIC WALKING | ACCESSORIES



POWDER PADDED STRAP
sold separately



Trail Click-In 2.1
strap



SPEED TOUR Carbon

- Sizes:**
· 115-145cm (in 5cm steps)
- Weight:**
· 154 g (125cm)
- Features:**
· EVA Cork Click-In Nordic grip
· NW Click-In 2.0 strap
· CX-100 Carbon
· Nordic BC basket
· tungsten/carbide tip

art. # 148 23 45-10

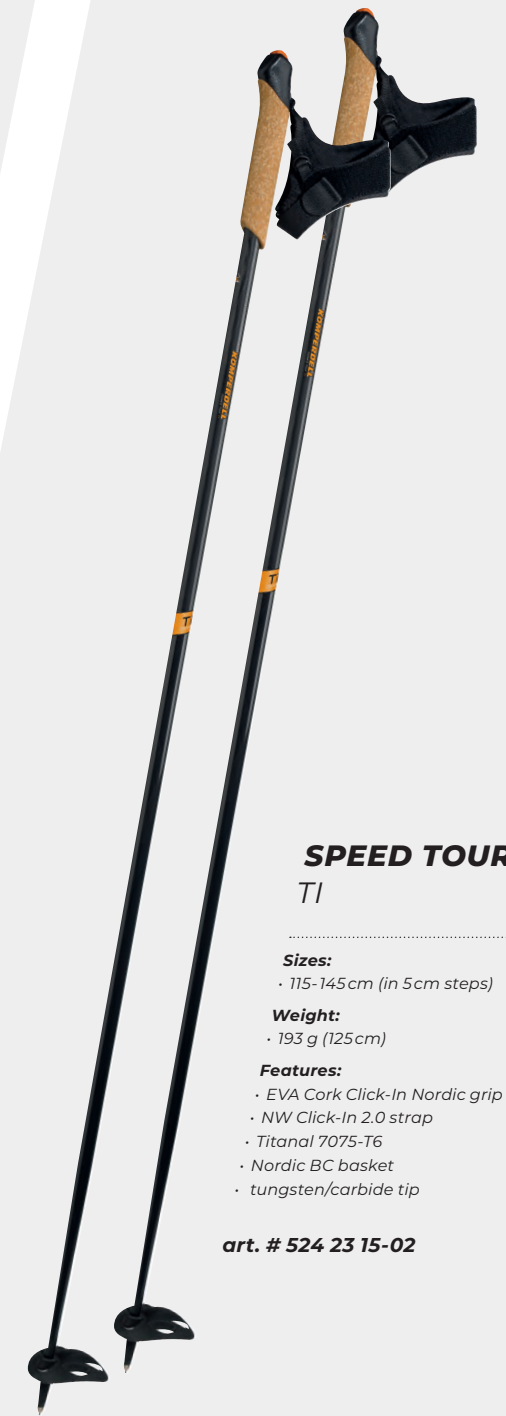

SPEED TOUR TI

- Sizes:**
· 115-145 cm (in 5cm steps)
- Weight:**
· 193 g (125cm)
- Features:**
· EVA Cork Click-In Nordic grip
· NW Click-In 2.0 strap
· Titanal 7075-T6
· Nordic BC basket
· tungsten/carbide tip

art. # 524 23 15-02



RACING | BIG MOUNTAIN | JUNIOR | RENTAL | TOURING | SNOWSHOES | NORDIC XC | PROTECTION | TREKKING | NORDIC WALKING | ACCESSORIES

TOURING SPLIT- BOARDING

RACING | BIG MOUNTAIN | JUNIOR | RENTAL | TOURING | SNOWSHOES | NORDIC XC | PROTECTION | TREKKING | NORDIC WALKING | ACCESSORIES



CARBON FXP.4 Expedition Vario

- Sizes:**
- packed size: 43 cm
 - adjustable from 120-140 cm
- Weight:**
- 248 g
- Features:**
- Touring Foam 280 grip
 - extended grip zone
 - Comfort Padded strap
 - 4-section:
 - upper section: Aluminum 7075-T6, Ø 18mm
 - lower section: Carbon Composite with Rocksleeve, Ø 16mm
 - Powerlock 3.0 mechanism
 - FXP folding mechanism
 - Regular UL FXP basket
 - Ice-Flex tungsten/carbide tip

art. # 194 23 61-10

OutDoor
by SPPO
Outstanding Outdoor
Gold Medal Sport
an SPPO Award



CARBON FXP.4 Expedition Vario Compact

- Sizes:**
- packed size: 38 cm
 - adjustable from 105-125 cm
- Weight:**
- 237 g
- Features:**
- Touring Foam 280 grip
 - extended grip zone
 - Comfort Padded strap
 - 4-section:
 - upper section: Aluminum 7075-T6, Ø 18mm
 - lower section: Carbon Composite with Rocksleeve, Ø 16mm
 - Powerlock 3.0 mechanism
 - FXP folding mechanism
 - Regular UL FXP basket
 - Ice-Flex tungsten/carbide tip

art. # 194 23 62-10

OutDoor
by SPPO
Outstanding Outdoor
Gold Medal Sport
an SPPO Award

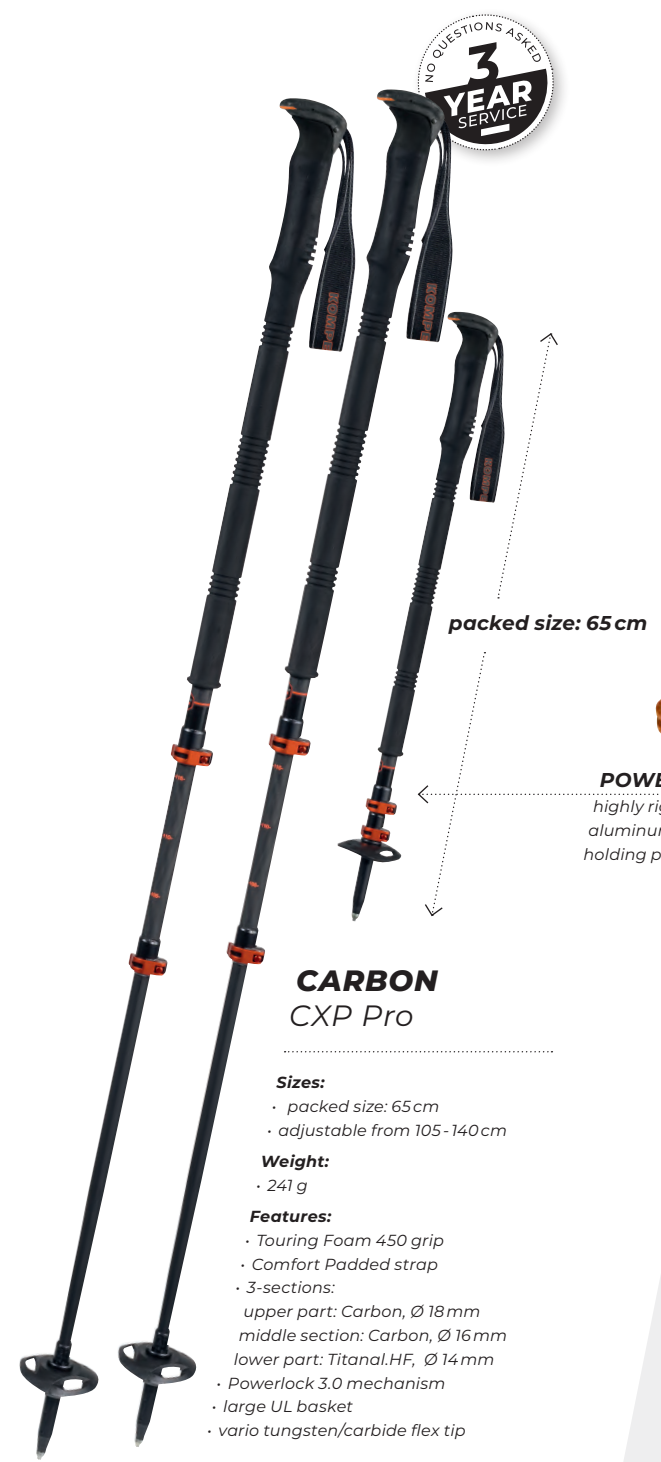

CARBON CXP Pro

- Sizes:**
- packed size: 65 cm
 - adjustable from 105-140 cm
- Weight:**
- 241 g
- Features:**
- Touring Foam 450 grip
 - Comfort Padded strap
 - 3-sections:
 - upper part: Carbon, Ø 18 mm
 - middle section: Carbon, Ø 16 mm
 - lower part: Titanal.HF, Ø 14 mm
 - Powerlock 3.0 mechanism
 - large UL basket
 - vario tungsten/carbide flex tip

art. # 175 23 54-10



TITANAL EXP Pro

- Sizes:**
- packed size: 65 cm
 - adjustable from 105-140 cm
- Weight:**
- 262 g
- Features:**
- Touring Foam 450 grip
 - Comfort Padded strap
 - 3-sections:
 - Titanal.HF, Ø 18/16/14 mm
 - Powerlock 3.0 mechanism
 - large UL basket
 - vario tungsten/carbide flex tip

art. # 174 23 55-10

AMAG
ROLLING
BACKLINE
ROLLING
PROTECT

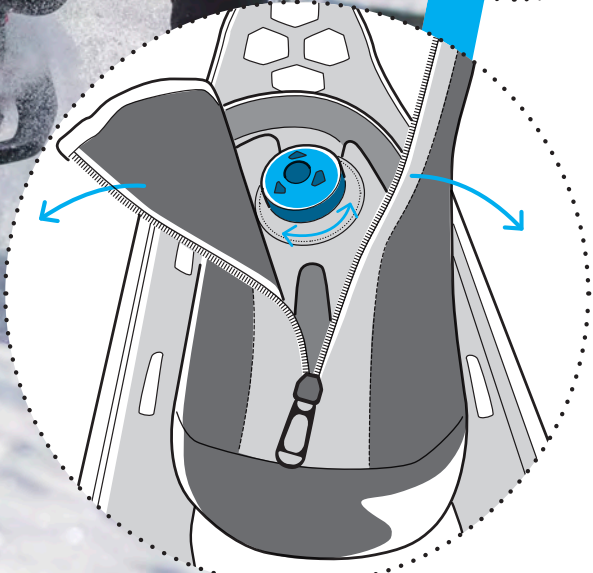
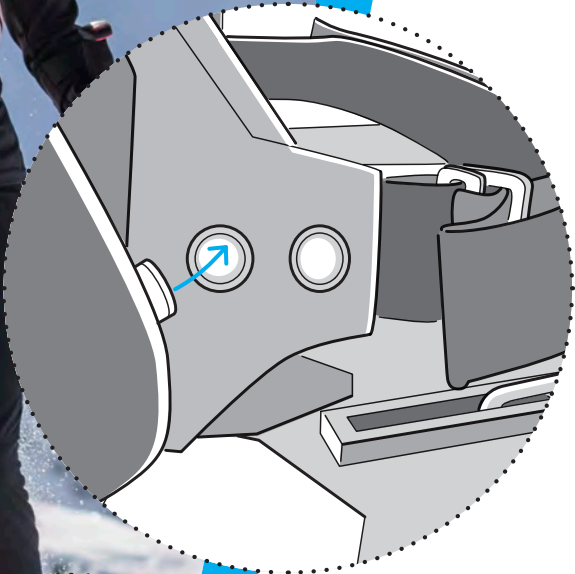

Wet feet? Out of the question!
Warming toe cover with ZIP access for binding adjustment. Super-fast push-button installation on all Komperdell snowshoes.

SNOWSHOES

THE WORLD'S LIGHTEST SNOWSHOE

Weighing just 691 grams, this innovative carbon snowshoe is incredibly strong. Its one-piece decking and hollow core air frame provide superior power transmission and an exceptionally light feel.



Best binding on the market.

QUICKLOCK BINDING
featuring a twist-lock mechanism for easy handling and a safe hold

50% LESS WEIGHT
thanks to an ultralight Carbon hollow core frame

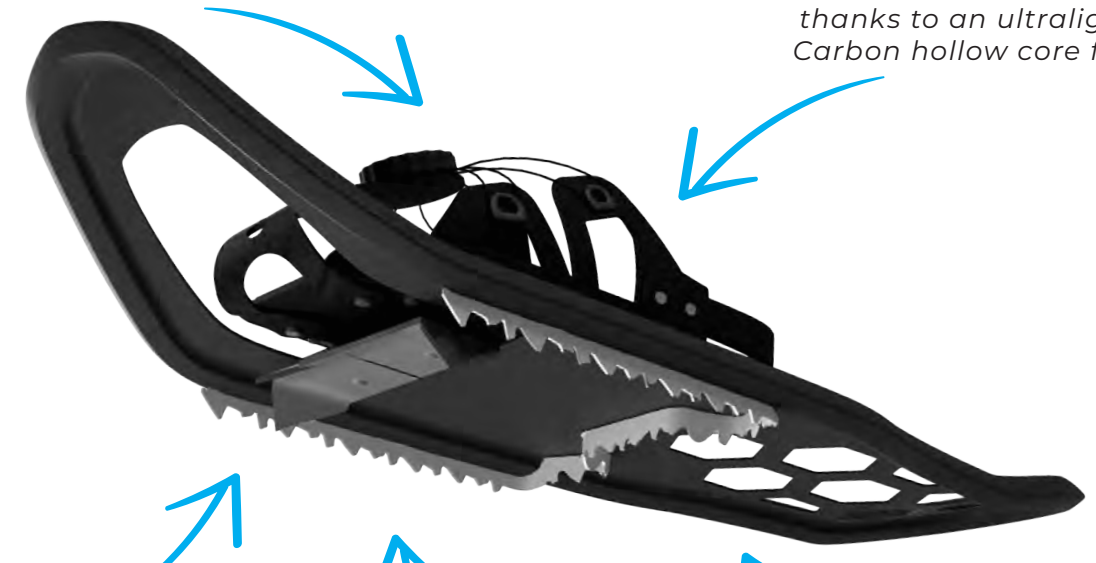

ICE-RAIL CLAWS
for ultimate grip on ice or hard-packed snow

DECKING AND FRAME MADE OF ONE PIECE
for maximum performance at minimum weight

ONLY 691 GRAMS

CARBON SNOWSHOES

100% Carbon! We offer the lightest snowshoe on the market. The result is truly amazing - 50 % less weight on your foot makes all the difference! You will feel it with every single step.



QUICKLOCK BINDING

super easy to adjust, fitting all sizes and types of boots and offering perfect hold

CARBON AIR FRAME 25

Size Binding:

- M, L

Weight:

- 691 g/piece

Features:

- integral built Carbon decking
- hollow-core Carbon frame, 50% less weight
- ice-rail claws – incredible traction on ice and hard packed snow
- new Quicklock binding – super easy to adjust, fitting all sizes and types of boots and offering perfect hold
- Neoprene Toe Cover

art. # 6508-10



Best binding on the market.



Neoprene Toe Cover included

CARBON SNOWSHOES



QUICKLOCK BINDING

super easy to adjust, fitting all sizes and types of boots and offering perfect hold

COMPOSITE AIR FRAME

Size Binding:

- M, L

Weight:

- 720 g/piece

Features:

- integral built Composite decking
- hollow-core Composite frame, 40% less weight
- ice-rail claws for optimal traction
- new Quicklock binding – super easy to adjust, fitting all sizes and types of boots and offering perfect hold
- Neoprene Toe Cover

art. # 6368-10



Best binding on the market.



Neoprene Toe Cover included

RACING | BIG MOUNTAIN | JUNIOR | RENTAL | TOURING | SNOWSHOES | NORDIC XC | PROTECTION | TREKKING | NORDIC WALKING | ACCESSORIES

RACING | BIG MOUNTAIN | JUNIOR | RENTAL | TOURING | SNOWSHOES | NORDIC XC | PROTECTION | TREKKING | NORDIC WALKING | ACCESSORIES

ALUMINUM SNOWSHOES

Indestructible yet lightweight and easy to use – The high performance aluminum frame and the Hypalon decking make the snowshoes durable and lightweight. The new Quicklock bindings are super easy to get in and provide a solid connection. The perfect allrounder for light to medium terrain.

OPTIONAL**Neoprene Toe Cover S-M-L**

- keeps your feet dry and warm
- easy attachment to the binding by push button system

art. # 6574-925

**PEAKMASTER PRO**
Snowshoe 30**Size & load capacity:**

- T30 - up to 120 kg (baggage included)
- binding L

Weight:

- T30 - 975 g/piece

Features:

- anodized high-performance aluminum frame
- durable Hypalon decking
- steel front claw and middle claw for traction in different conditions
- Heel Lift
- comfortable Quicklock binding

art. # 6640-10 T30 red



Best binding on the market.

ALUMINUM SNOWSHOES

**PEAKMASTER PRO**
Snowshoe 25**Size & load capacity:**

- T25 - up to 100 kg (baggage included)
- binding M

Weight:

- T25 - 905 g/piece

Features:

- anodized high-performance aluminum frame
- durable Hypalon decking
- steel front claw and middle claw for traction in different conditions
- Heel Lift
- comfortable Quicklock binding

art. # 6641-10 T25 blue



Best binding on the market.

**PEAKMASTER PRO**
Snowshoe 22**Size & load capacity:**

- T22 - up to 80 kg (baggage included)
- binding M

Weight:

- T22 - 833 g/piece

Features:

- anodized high-performance aluminum frame
- durable Hypalon decking
- steel front claw and middle claw for traction in different conditions
- Heel Lift
- comfortable Quicklock binding

art. # 6642-10 T22 ribes



Best binding on the market.



SNOWSHOE ACCESSORIES



NEOPRENE TOE COVER

Sizes:

- S, M, L

Features:

- keeps your feet dry and warm
- easy attachment to the binding by push button system

art. # 6574-925



NEOPRENE GAITER

Sizes:

- S, L

Features:

- protects from wind, moisture and cold
- optimal fit, easy length adjustment with cord

art. # 6575-925



SEAMLESS Titanium 0,5 mm

Sizes:

- from 35/36 to 47/48

Features:

- Seamless Bonding System for best wearing comfort
- suitable for common outdoor shoes
- keeps your feet dry and warm

art. # 6573-925



TPU Snowshoe Binding

Size Binding:

- S, M, L

Features:

- separate Easy-Step-In Binding
- suitable for common outdoor shoes
- optimal, comfortable fitting

art. # 6572-925



QUICKLOCK Snowshoe Binding

Size Binding:

- M, L

Features:

- separate Quicklock binding with lacing system
- suitable for common outdoor shoes
- optimal, comfortable fitting

art. # 6643-925



NORDIC XC CX-80

Our carbon shafts are truly superior – unrivaled in the ratio of weight to stiffness. A guarantee for maximum speed.



SIZE CHART FOR CLASSIC & RACING

Person Height	Stick Length
140 cm	120 cm
145 cm	125 cm
150 cm	130 cm
155 cm	135 cm
160 cm	140 cm
165 cm	145 cm
170 cm	150 cm
175 cm	155 cm
180 cm	160 cm
185 cm	165 cm
190 cm	170 cm
195 cm	175 cm
200 cm	180 cm



NORDIC XC

CX-80

Tube can be cut to individual length
to the optimal length for ambitious athletes

NORDIC CX-80 National Team

Sizes:
· individually adaptable
140/150/160/170/180 cm

Weight:
· 148 g (155 cm)

Features:
· especially nonslip Nordic 2K cork grip
· Click-in race strap
· Carbon, Ø 16mm
· weight 80 g/150cm/bending 15mm
· Nordic track UL basket
· tungsten/carbide tip

art. # 520 23 25-10

NORDIC CX-80 Track Yellow

Sizes:
· 120-180 cm (in 5 cm steps)

Weight:
· 150 g (155 cm)

Features:
· especially nonslip Nordic 2K cork grip
· Click-in race strap
· Carbon, Ø 16mm
· weight 80 g/150cm/bending 15mm
· Nordic track UL basket
· tungsten/carbide tip

ART. #520 23 26-10

CX-80
our lightest and stiffest Carbon shafts

NORDIC XC CX-100

Perfect in terms of weight, stiffness, and value for money. The proven Click-In strap is not only easy to use but also fits perfectly ergonomically.



Get in with "Click", go out with "Push". Our proven Click-in system could not be easier.

SIZE CHART FOR SKATING

140 cm	110 cm
145 cm	115 cm
150 cm	120 cm
155 cm	125 cm
160 cm	130 cm
165 cm	135 cm
170 cm	140 cm
175 cm	145 cm
180 cm	150 cm
185 cm	155 cm
190 cm	160 cm
195 cm	165 cm
200 cm	170 cm

SIZE CHART FOR CLASSIC & RACING

140 cm	120 cm
145 cm	125 cm
150 cm	130 cm
155 cm	135 cm
160 cm	140 cm
165 cm	145 cm
170 cm	150 cm
175 cm	155 cm
180 cm	160 cm
185 cm	165 cm
190 cm	170 cm
195 cm	175 cm
200 cm	180 cm

NORDIC XC CX-100



natural cork grip
sweat absorbing and light

extra stiff cx-100 shaft
improved transmission of force

NORDIC CX-100 Cork

Sizes:
• 120-180 cm (in 5cm steps)
Weight:
• 168 g (155cm)

Features:
• padded Nordic 2K Cork grip
• Click-In race strap
• Carbon, Ø 16mm
• weight 100g/150cm/bending 17.5mm
• Nordic trail UL basket
• tungsten/carbide tip

- art. # 520 23 27-10 yellow
- art. # 520 23 28-10 red
- art. # 520 23 29-10 blue
- art. # 520 23 30-10 pink

NORDIC CX-100 Sport

Sizes:
• 120-180 cm (in 5cm steps)
Weight:
• 170 g (155cm)

Features:
• especially nonslip Nordic 2K rubber grip
• Click-In race strap
• Carbon, Ø 16mm
• weight 100g/150cm/bending 17.5mm
• Nordic trail UL basket
• tungsten/carbide tip

- art. # 520 23 17-10 yellow
- art. # 520 23 18-10 red
- art. # 520 23 19-10 blue
- art. # 520 23 20-10 pink

NORDIC XC ADVENTURE

BRAND
NEW
10 QUESTIONS ASKED
3
YEAR
SERVICE

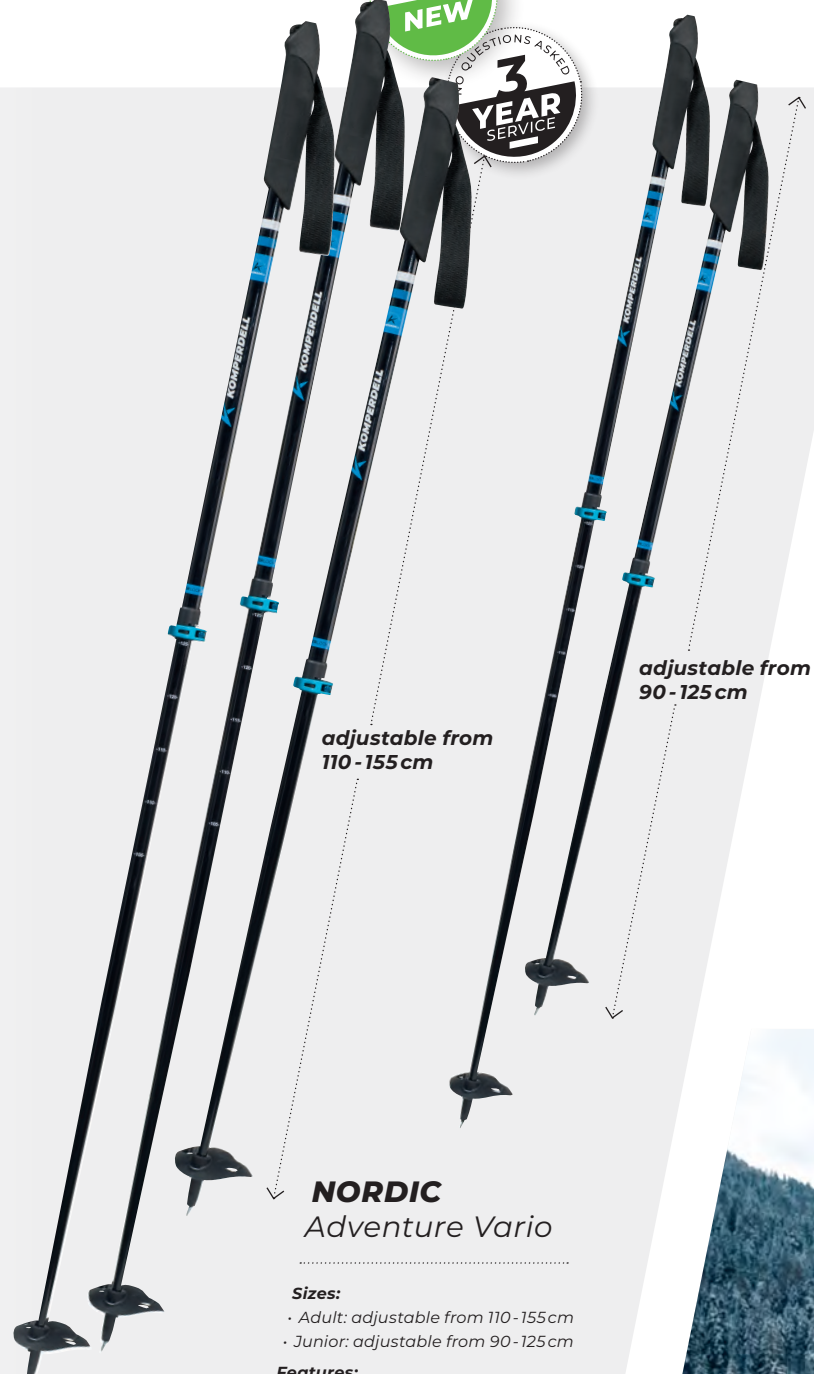

adjustable from
110 - 155cm

adjustable from
90 - 125cm

NORDIC Adventure Vario

- Sizes:**
- Adult: adjustable from 110 - 155cm
 - Junior: adjustable from 90 - 125cm

- Features:**
- Nordic foam grip
 - padded Nordic strap
 - 2-sections:
Aluminum 7075, Ø 18/16mm
 - Powerlock 3.0 mechanism
 - BC Nordic basket
 - Nordic steel tip

art. # 184 23 64-02 adult
art. # 164 23 18-10 junior



NORDIC Adventure

- Sizes:**
- 120 - 160 cm (in 5cm steps)
- Features:**
- Nordic foam grip
 - padded Nordic strap
 - Aluminum 5086, Ø 16mm
 - BC Nordic basket
 - Nordic steel tip

art. # 522 23 10-02



NORDIC Prime

- Sizes:**
- 120 - 160 cm (in 5cm steps)
- Features:**
- XC cork grip
 - padded Nordic strap
 - Aluminum 5086, Ø 16mm
 - XC standard basket
 - Nordic steel tip

art. # 522 23 11-12



NORDIC Classic

- Sizes:**
- Adult: 120 - 160 cm (in 5cm steps)
 - Junior: 90 - 115 cm (in 5cm steps)
- Features:**
- Nordic XC grip
 - Nordic classic strap
 - Aluminum 5083, Ø 16mm
 - XC standard basket
 - Nordic steel tip

art. # 522 11 02-10 adult
art. # 222 11 21-10 junior



PROTECTION

MAXIMUM PROTECTION WITH BEST WEARING COMFORT

We are the only brand to develop our proprietary protective foam as well as the garment on our own. This results in a perfectly harmonizing protection system without sacrificing safety and comfort.

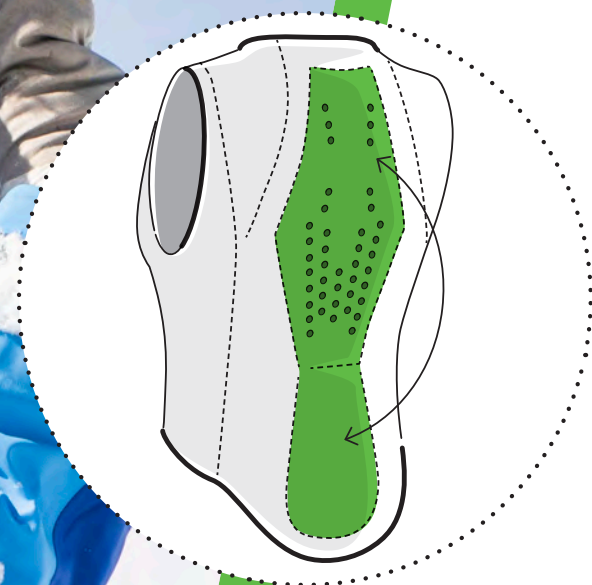

Distribution of the impact forces
Protective zone over the entire back.

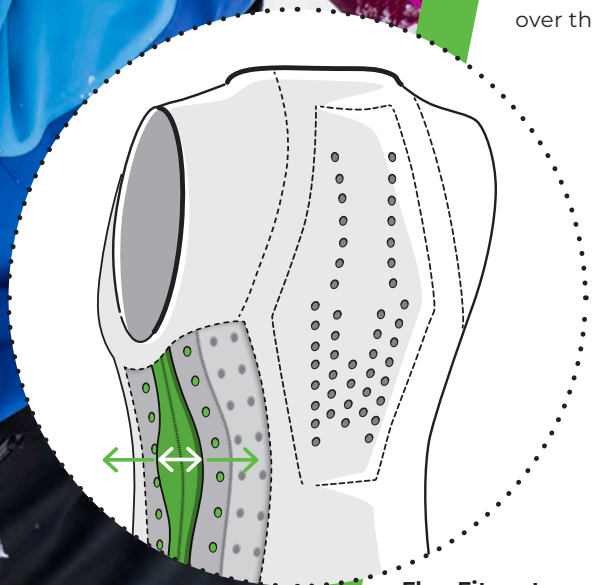

Flex-Fit system
Automatic width adjustment with full torso protection.

TOP RESIDUAL FORCE VALUES
absorbs up to 93% of the impact energy, independent of temperature and humidity

LARGEST PROTECTION ZONE
providing continuous protection from the 7th cervical vertebra to the coccyx

WASHABLE
without problems at 30°

100% BREATHABLE
thanks to generous perforation and integrated air-mesh

UNLIMITED MULTI-IMPACT CAPABLE
does not have to be replaced after a fall

UNIQUE WEARING COMFORT
thanks to a clever and flexible multilayer system hardly noticed when worn

25% lighter
with the same level of impact protection thanks to a new protective foam



ISPO AWARD 2024 WINNER



Every cut is the first step
on the way to a masterpiece - from the
first sketch to the finished product.“

Peter, Elisabeth and Klara, Design & Development



AWARD WINNING PROTECTOR TECHNOLOGY

Our technology is market leading. We are the only brand to develop our own protector. Both the foam and the protector are proprietary. We have the lowest residual force levels and the largest continuously protected area. Our protector technology has already won more than 50 international awards.

ONE-STOP INNOVATION

The protector as well as the garment are developed in our headquarters in Mondsee. We control every step from the first idea up to the final product. In addition to our own brand, we develop, design and manufacture protectors for some of the world's leading motorcycle and workwear brands.

25 YEARS KNOW-HOW

We have always been true innovators and market leaders. When we started with protection 25 years ago, we created the look and feel of the modern protector as we know it today. We were the pioneer brand offering an alternative to the hardshell protector and have always led the market in both comfort and protective properties.

PROTECTION

Ultimate protection. These models offer best protection for the safety-conscious on- or off-piste skier. Choose from 360° full torso protection or protective inserts on chest or sides.



PROTECTION

ATHLETIC

**BALLISTIC FLEX FIT****Sizes:**

- Regular: XXS-XXL
- Women: XXS-XXL

Features:

- multilayer Cross Flex back-protector, made of adaptive dual-density foam, EN-approved 1621-, level 2
- light and flexible
- highest safety values - 360° all around protection
- for ultimate mobility
- front zip

■ art. # 6448-212 regular

■ art. # 6447-212 women

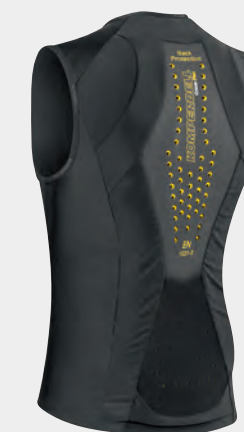
**AIR VEST +****Sizes:**

- unisex, XS - XL

Features:

- multilayer Cross Flex back-protector made of adaptive dual-density foam, EN-approved 1621-2, level 2
- light and flexible
- semi-removable chest protectors
- front zip

art. # 6599-206 unisex



semi-removable chest protectors
certified according to the motorcycle standard EN 1621-3

extra strong, elastic rubber binding
to ensure a secure hold

ULTRAFLEX PRO

The new Ultraflex Pro vest protects not only the whole spine, but also ribs and soft tissues thanks to additional lateral protective foams. The super soft and flexible material ensures unparalleled wearing comfort.

RACING | BIG MOUNTAIN | JUNIOR | RENTAL | TOURING | SNOWSHOES | NORDIC XC | PROTECTION | TREKKING | NORDIC WALKING | ACCESSORIES



PRO SHORT

Sizes:
· unisex: XXS-XXL

- Features:**
- comfortable foam material for optimal protection of coccyx, thighs and hips
 - hidden zipper to connect Ultraflex Air Vest and Ultraflex Pro Vest
 - sporty look

art. # 6704-2

BRAND NEW



hidden zipper
to connect Ultraflex Air Vest
and Ultraflex Pro Vest



ULTRA FLEX PRO

Lateral rib and soft tissue protection



BRAND NEW

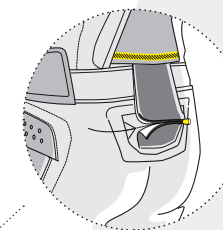

hidden zipper
to connect Ultraflex Air Vest
and Ultraflex Pro Vest



ULTRAFLEX PRO Women

Sizes:
· XS-XL

- Features:**
- multilayer Cross Flex back-protector made of adaptive dual-density foam, EN-approved 1621-2, level 2
 - lateral protective foams to protect ribs and soft tissues
 - extra light and flexible
 - hidden zipper to connect Pro Short
 - optimized silhouette
 - front zip

art. # 6699-2

BRAND NEW

ULTRAFLEX PRO Men

Sizes:
· S-XXL

- Features:**
- multilayer Cross Flex back-protector made of adaptive dual-density foam, EN-approved 1621-2, level 2
 - lateral protective foams to protect ribs and soft tissues
 - extra light and flexible
 - hidden zipper to connect Pro Short
 - optimized silhouette
 - front zip

art. # 6698-2



Lateral rib and soft tissue protection



RACING | BIG MOUNTAIN | JUNIOR | RENTAL | TOURING | SNOWSHOES | NORDIC XC | PROTECTION | TREKKING | NORDIC WALKING | ACCESSORIES

ULTRAFLEX AIR

Protection has never been so lightweight and comfortable. The new Ultraflex Air vest offers top-notch back protection without feeling bulky. The super soft and flexible material makes the vest feel like a second skin and ensures unparalleled wearing comfort.

RACING | BIG MOUNTAIN | JUNIOR | RENTAL | TOURING | SNOWSHOES | NORDIC XC | PROTECTION | TREKKING | NORDIC WALKING | ACCESSORIES



PRO SHORT

- Sizes:**
- unisex: XXS-XXL
- Features:**
- comfortable foam material for optimal protection of coccyx, thighs and hips
 - hidden zipper to connect Ultraflex Air Vest and Ultraflex Pro Vest
 - sporty look

art. # 6704-2



hidden zipper to connect Ultraflex Air Vest and Ultraflex Pro Vest



ULTRA FLEX AIR

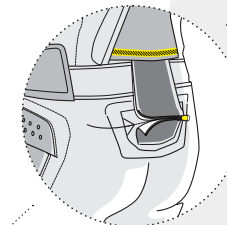

hidden zipper to connect Ultraflex Air Vest and Ultraflex Pro Vest

ULTRAFLEX AIR Men

- Sizes:**
- XS-XXL
- Features:**
- multilayer Cross Flex back-protector made of adaptive dual-density foam, EN-approved 1621-2, level 2
 - extra light and flexible
 - hidden zipper to connect Pro Short
 - optimized silhouette
 - front zip

art. # 6700-2



ULTRAFLEX AIR Women

- Sizes:**
- XS-XL
- Features:**
- multilayer Cross Flex back-protector made of adaptive dual-density foam, EN-approved 1621-2, level 2
 - extra light and flexible
 - hidden zipper to connect Pro Short
 - optimized silhouette
 - front zip

art. # 6701-2



RACING | BIG MOUNTAIN | JUNIOR | RENTAL | TOURING | SNOWSHOES | NORDIC XC | PROTECTION | TREKKING | NORDIC WALKING | ACCESSORIES

CORE VEST LIGHT

BRAND NEW



CORE VEST LIGHT Women

Sizes:

- XS - XL

Features:

- multilayer Cross Flex back-protector made of adaptive dual-density foam, EN-approved 1621-2, level 2
- detachable protector insert
- light and flexible
- front zip

art. # 6703-2

BRAND NEW



CORE VEST LIGHT Men

Sizes:

- XS - XXL

Features:

- multilayer Cross Flex back-protector made of adaptive dual-density foam, EN-approved 1621-2, level 2
- detachable protector insert
- light and flexible
- front zip

art. # 6702-2

PROTECTOR PACK

BRAND NEW



removable strap system
eliminates pressure points

top residual force values

Height-adjustable kidney belt
for perfect fit

multi impact capable

PROTECTOR PACK Men

Sizes:

- XXS - XL

Features:

- multilayer Cross Flex back-protector made of adaptive dual-density foam, EN-approved 1621-2, level 2
- confirms to FIS regulations
- anatomic shaped back for best fit
- new detachable strap system – shoulder it like a backpack
- protector insert visible - part of the design concept
- ultimate freedom of movement
- height-adjustable kidney belt for perfect fit, adjustable with velcro and plush

art. # 6696-2

BRAND NEW



removable strap system
eliminates pressure points

top residual force values

Height-adjustable kidney belt
for perfect fit

multi impact capable

meets FIS regulations

removable strap system
eliminates pressure points

Height-adjustable kidney belt
for perfect fit

PROTECTOR PACK Junior

Sizes:

- 128-152

Features:

- multilayer Cross Flex back-protector made of adaptive dual-density foam, EN-approved 1621-2, level 2
- confirms to FIS regulations
- anatomic shaped back for best fit
- new detachable strap system – shoulder it like a backpack
- protector insert visible - part of the design concept
- ultimate freedom of movement
- height-adjustable kidney belt for perfect fit, adjustable with velcro and plush

art. # 6697-2

RACING | BIG MOUNTAIN | JUNIOR | RENTAL | TOURING | SNOWSHOES | NORDIC XC | PROTECTION | TREKKING | NORDIC WALKING | ACCESSORIES

RACING | BIG MOUNTAIN | JUNIOR | RENTAL | TOURING | SNOWSHOES | NORDIC XC | PROTECTION | TREKKING | NORDIC WALKING | ACCESSORIES

PROTECTION CASUAL



Hoody
made of super-soft fleece,
snugly & warm

FULL ZIP HOODY

Sizes:
· Men: XS - XXL
· Women: XXS - XL

Features:
· multilayer Cross FLEX back-protector, made of adaptive dual-density foam, EN-approved 1621-2, level 2
· made of comfortably fitting fleece
· 4-way stretch- material
· hood with draw-string
· integrated kidney-belt, adjustable with velcro fastener

■ art. # 6353-207 men
■ art. # 6356-240 women

Kangaroo Pockets



Cross Flex Protector
the safest protection –
EN 1621-2

FULL ZIP SWEATER Bond Material

Sizes:
· Men: XS - XXL
· Women: XXS - XL

Features:
· multilayer Cross FLEX back-protector, made of adaptive dual-density foam, EN-approved 1621-2, level 2
· made of comfortably fitting fleece
· 4-way stretch- material
· integrated kidney-belt, adjustable with velcro fastener
· front zip

■ art. # 6354-207 men
■ art. # 6357-240 women



FULL ZIP SWEATER Sonic Material

Sizes:
· Men: XS - XXL
· Women: XXS - XL

Features:
· multilayer Cross FLEX back-protector, made of adaptive dual-density foam, EN-approved 1621-2, level 2
· made of comfortably fitting fleece
· 4-way stretch- material
· integrated kidney-belt, adjustable with velcro fastener
· front zip

■ art. # 6354-202 men
■ art. # 6357-209 women



Cross Flex Protector
the safest protection –
EN 1621-2, level 2

PROTECTION CASUAL MEN



RACING
BIG MOUNTAIN
JUNIOR
RENTAL
TOURING
SNOWSHOES
NORDIC XC
PROTECTION
TREKKING
NORDIC WALKING
ACCESSORIES



best cold & wind protection
due to thermo-isolating, extra light technical materials



SOFTSHELL VEST Men

Sizes:
· XS - XL

- Features:**
- multilayer Cross 6.0 back-protector, made of adaptive dual-density foam, EN-approved 1621-2, level 2
 - chest pocket
 - inside pockets with zip
 - Nutrition pocket
 - reflective prints
 - front zip

art. # 6605-206

THERMOVEST Men

Sizes:
· S - XXL

- Features:**
- multilayer Cross 6.0 back-protector, made of adaptive dual-density foam, EN-approved 1621-2, level 2
 - innovative material-mix: extra-light shell material combined with smart breathable thermo-padding
 - removeable hood stormproof
 - concealed chest pocket with zip & 2 concealed side-pockets

art. # 6351-207



removeable hood
fully customizable with draw-string and rubber cord



integrated kidney-belt
adjustable with velcro-fastener

RACING
BIG MOUNTAIN
JUNIOR
RENTAL
TOURING
SNOWSHOES
NORDIC XC
PROTECTION
TREKKING
NORDIC WALKING
ACCESSORIES

PROTECTION KIDS CORNER

Protect your child in the best possible way! The Ballistic FlexFit Junior offers unparalleled protection with our unique 360° all-round protection, while remaining as light and flexible as a second layer of clothing. Thanks to overlapping protective foams, the vest expands up to 2 sizes in width without compromising protection, ensuring a perfect fit over or under any jacket.



PROTECTION KIDS CORNER



Cross 8.0 Protector
the safest protection – EN 1621-2 Level 2

BALLISTIC FLEX FIT PRO JUNIOR green

Sizes:
· 104-152

- Features:**
- multilayer Cross 8.0 back-protector, made of adaptive dual-density foam, EN-approved 1621-2 level 2
 - 360° all around protection - top protection values
 - automatic width adjustment without compromising protection thanks to overlapping protective foams
 - extremely lightweight & breathable protector
 - with front zipper – easier to put on and take off
 - unlimited freedom of movement
 - improved ergonomics

art. # 6691-213

ISPO AWARD 2024 WINNER

NEW SIZE 104

40% better protection – Level 2 certified

BALLISTIC FLEX FIT PRO JUNIOR pink

Sizes:
· 104-152

- Features:**
- multilayer Cross 8.0 back-protector, made of adaptive dual-density foam, EN-approved 1621-2, level 2
 - 360° all around protection - top protection values
 - automatic width adjustment without compromising protection thanks to overlapping protective foams
 - extremely lightweight & breathable protector
 - with front zipper – easier to put on and take off
 - unlimited freedom of movement
 - improved ergonomics

art. # 6692-209

ISPO AWARD 2024 WINNER

NEW SIZE 104

40% better protection – Level 2 certified



Cross 8.0 Protector
the safest protection – EN 1621-2 Level 2

automatic width adjustment

RACING JUNIOR BIG MOUNTAIN JUNIOR RENTAL TOURING SNOWSHOES NORDIC XC PROTECTION TREKKING NORDIC WALKING ACCESSORIES

/ 107 RACING JUNIOR BIG MOUNTAIN JUNIOR RENTAL TOURING SNOWSHOES NORDIC XC PROTECTION TREKKING NORDIC WALKING ACCESSORIES

PROTECTION KIDS CORNER



PRO SHORT Junior

Sizes:
· 116 - 152

Features:
· comfortable foam material for optimal protection of hips
· slip-proof rubber band at waist and legs

art. # 6709-02



AIR VEST JUNIOR pink

Sizes:
· 104 - 152

Features:
· multilayer Cross Eco Junior back protector made of adaptive dual-density foam, EN-approved 1621-2, level 1
· light and flexible

art. # 6452-243

 ISPO AWARD
WINNER
2016/2017



AIR VEST JUNIOR green

Sizes:
· 104 - 152

Features:
· multilayer Cross Eco Junior back protector made of adaptive dual-density foam, EN-approved 1621-2, level 1
· light and flexible

art. # 6450-18

 ISPO AWARD
WINNER
2016/2017



RACING PROTECTION



BRAND NEW



perforated neoprene

FLEX PROTECTOR Knee-Air

Sizes:
 · Adult: S-M-L
 · Junior: S-M

Features:
 · EN-approved 1621-1 – Level 1
 · to slip in
 · light and breathable

art. # 6632-206 adult
art. # 6633-206 junior

Bag for Knee protector
 super small packed size



Especially soft and 7 mm thin protector EN 1621-1 Level 1.

FLEX PROTECTOR Elbow-Air

Sizes:
 · S-M-L

Features:
 · EN-approved 1621-1 – Level 1
 · to slip in
 · light and breathable

art. # 6630-206 adult
art. # 6631-206 junior

BRAND NEW



perforated neoprene

Bag for Elbow protector
 super small packed size



RACING PROTECTION

BRAND NEW



PROTECTOR PACK

Sizes:
 · Men: XXS-XL
 · Junior: 128-152

- Features:**
- multilayer Cross Flex back-protector made of adaptive dual-density foam, EN-approved 1621-2, level 2
 - confirms to FIS regulations
 - anatomic shaped back for best fit
 - new detachable strap system – shoulder it like a backpack
 - protector insert visible - part of the design concept
 - ultimate freedom of movement
 - height-adjustable kidney belt for perfect fit, adjustable with velcro and plush

art. # 6696-2 men
 art. # 6697-2 junior



FULL PROTECTOR Slalom Shirt Long

Sizes:
 · Adult: XS-XL
 · Junior: 116-152

- Features:**
- perfect breathability, comfortable to wear
 - multilayer Cross 6.0 back-protector, made of adaptive dual-density foam, EN-approved 1621-2, level 2
 - perfect protection of back, shoulders, shoulderblades & arms

art. # 6301-208 adult
 art. # 6302-208 junior



PROTECTOR Slalom Shirt

Sizes:
 · Adult: XS-XL
 · Junior: 116-152

- Features:**
- perfect breathability, comfortable to wear
 - body-shape cut
 - multilayer protectors made of dual-density foam
 - perfect protection of shoulders, shoulderblades and arms
 - specially shaped back for perfect combination with the FIS approved Protector Pack

art. # 6283-2 adult
 art. # 6284-2 junior



RACING | BIG MOUNTAIN | JUNIOR | RENTAL | TOURING | SNOWSHOES | NORDIC XC | PROTECTION | TREKKING | NORDIC WALKING | ACCESSORIES

RACING | BIG MOUNTAIN | JUNIOR | RENTAL | TOURING | SNOWSHOES | NORDIC XC | PROTECTION | TREKKING | NORDIC WALKING | ACCESSORIES

COLD PROTECTION



STORMHOOD

Sizes:
· Junior/Adult

Features:
· BC-Flex with rapid-dry function
· 4-way stretch – extra elastic
· perfect to be worn under helmet

art. # 6210-2 adult
art. # 6211-2 junior



NEOPRENE MASK

Sizes:
· Junior/Adult

Features:
· neoprene material
· fully adjustable with velcro fastener

art. # 694-2 adult
art. # 603-2 junior



KNITTED NOSTALGIC CAP

Sizes:
· Unisex

Features:
· 100% soft acrylic
· retro look – still a sales hit

art. # 602-1 white/red
art. # 602-2 black/red



THERMO MITTENS

Sizes:
· S/L

Features:
· neoprene mitten to wear over a 5-finger glove
· optimal heat insulation in case of low temperatures
· multifunctional usage

art. # 405-2



junior

RACING LOBSTER

Sizes:
· Adult: XS - XL
· Junior: S - XL

Features:
· genuine leather
· special heat insulation
· knuckles protection out of Carbon (only Adult)
· shock absorbing foam on fingers, thumb and back of the hand

art. # 6502-2 adult
art. # 6621-2 junior



junior

RACING GLOVE

Sizes:
· Adult: XS - XL
· Junior: S - XL

Features:
· genuine leather
· special heat insulation
· knuckles protection out of Carbon (only Adult)
· shock absorbing foam on fingers, thumb and back of the hand

art. # 6501-2 adult
art. # 6620-2 junior



LEATHER GLOVES

Sizes:
· S(6,5) M(7,5) L(9) XL(10)

Features:
· genuine leather
· extra warm

art. # 441-2



Merino Wool →



FREERIDE LIGHT

Sizes:
· XS - XL

Features:
· seamless: wind- & waterproof
· breathable 4-layer material concept
· palm with abrasion-resistant kevlar-material
· merino wool mix inside lining for optimal heat insulation

art. # 447-2

BC Flex
outerliving →



TOURING BC FLEX

Sizes:
· XS - XXL

Features:
· seamless: wind- & waterproof
· 3-layer material concept
· odour-neutralizing & breathable
· humidity-absorbing
· palm with non-slip material
· comfortable soft brushed BC-Flex inside-lining
· extra light & thin material

art. # 410-2

Frottee
outer- and interlining →



TOURING FROTTEE

Sizes:
· XS - XL

Features:
· seamless: wind- & waterproof
· 3-layer material concept
· breathable & humidity-absorbing
· palm, with non-slip reinforced
· extra warm terry cloth lining for cold winter tours
· middle- and ring finger made of soft-shell material

art. # 411-3



FXP TRAIL

MINIMALISTIC. PURISTIC. EFFICIENT.

"The wow effect in every race! As soon as I got the chance to test the prototype, I knew I need this stylish pole as quickly as possible! Super light, highly functional, handling in seconds - exactly what I have always imagined."

Jens Kramer, professional trail runner



Can be used in seconds by simply hooking the loops in the handle head.

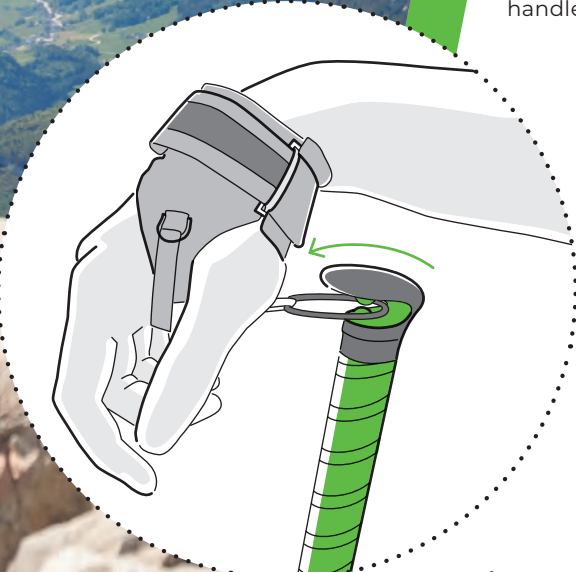

Decoupling made easy
Pull your hand forward over the handle head. Release the ring with a short pull.

READY TO USE WITHIN SECONDS
by simply hooking in the straps

ROBUST GRIP HEAD
to secure a safe hold

CHANGEABLE GRIP TAPES
to style your pole according to your preferences

INNOVATIVE FLY STRAP SYSTEM
for maximum power transmission

EXTREMELY SMALL PACKED SIZE
fits in conventional quiver

IMMEDIATELY READY TO USE
thanks to our award-winning self-deploying FXP mechanism



ISPO AWARD 2024 WINNER

FXP CARBON ULTRA

The Carbon FXP trail running poles set new standards in terms of performance, comfort and design. Completely rethought and reduced to the essentials - exactly what performance-oriented trail runners with highest demands are looking for.



The combination makes the difference:

Only 14mm shaft diameter and the self-deploying FXP mechanism guarantee a smooth handling when pulling the poles out of the quiver. Ready to use in a matter of seconds.

+ ADVANTAGES AT A GLANCE

- + particularly small pack size, fits perfectly in conventional quivers
- + the minimized shape saves weight and ensures agile handling
- + our innovative Fly strap system guarantees easy handling and maximum power transmission
- + thanks to the patented FXP folding mechanism, the pole unfolds completely by itself when released

CARBON FXP ULTRA

+ OPTIONALLY AVAILABLE

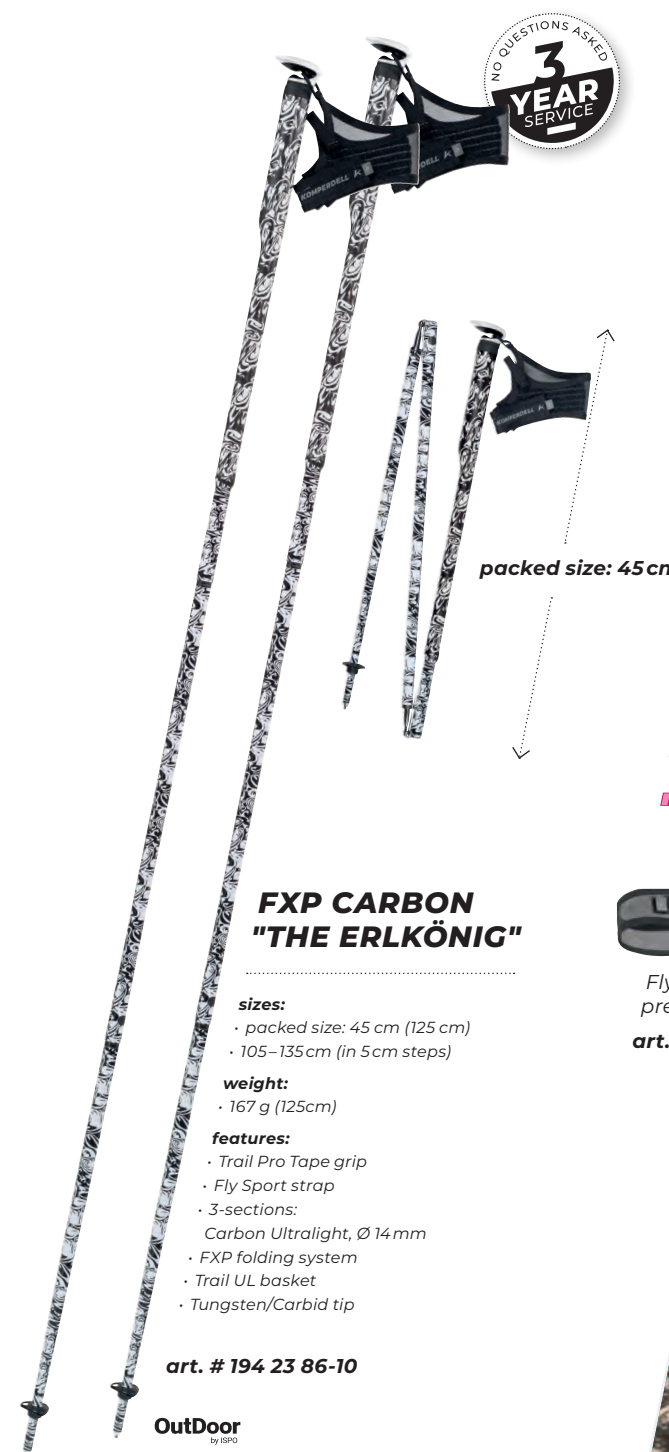

packed size: 45 cm

FXP CARBON "THE ERLKÖNIG"

sizes:
· packed size: 45 cm (125 cm)
· 105-135 cm (in 5 cm steps)

weight:
· 167 g (125cm)

features:
· Trail Pro Tape grip
· Fly Sport strap
· 3-sections:
Carbon Ultralight, Ø 14 mm
· FXP folding system
· Trail UL basket
· Tungsten/Carbid tip

art. # 194 23 86-10

OutDoor
by ISPO
Outstanding Outdoor
LIFE MEMBER 2019
an ISPO award



FXP Tape, pre-packed

art. # 8292-925
Erlkönig Original

art. # 8280-925
Erlkönig Green

art. # 8282-925
Erlkönig Pink



Fly Loop Strap
pre-packed
art. # 7031-925

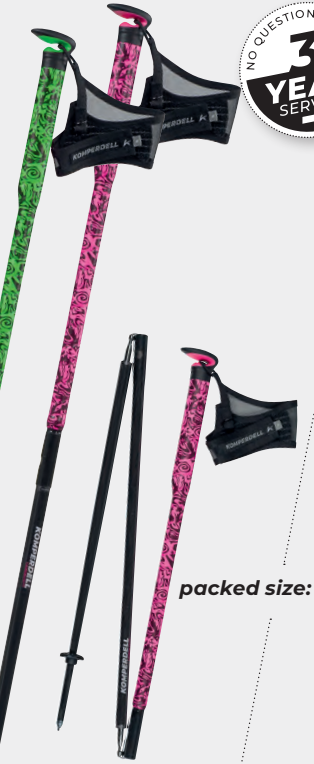

packed size: 45 cm

FXP CARBON ULTRA Green/Pink

sizes:
· packed size: 45 cm (125 cm)
· 105-135 cm (in 5 cm steps)

weight:
· 167 g (125cm)

features:
· Trail Pro Tape grip
· 1 spare tape included (green/pink)
· Fly Sport strap
· 3-sections:
Carbon Ultralight, Ø 14 mm
· FXP folding system
· Trail UL basket
· Tungsten/Carbid tip

art. # 194 23 74-48

OutDoor
by ISPO
Outstanding Outdoor
LIFE MEMBER 2019
an ISPO award



COMPOSITE FXP TRAIL



PIMP YOUR POLE!



spare tape included



packed size: 45 cm

FXP COMPOSITE TRAIL Green

sizes:
· packed size: 45 cm (125 cm)
· 105-135cm (in 5cm steps)

weight:
· 199 g (125cm)

features:
· Trail Pro Tape grip
· 1 spare tape included (solid green)
· Fly Sport strap
· 3-sections:
Carbon composite, Ø 16 mm
· FXP folding system
· Trail UL basket
· Tungsten/Carbid tip

art. # 194 23 76-10

OutDoor
by SPPO
Outstanding Outdoor

+ OPTIONALLY AVAILABLE



Fly Loop Schlaufe
pre-packed
art. # 7031-925



PIMP YOUR POLE!



spare tape included



packed size: 45 cm

FXP COMPOSITE TRAIL Blue

sizes:
· packed size: 45 cm (125 cm)
· 105-135cm (in 5cm steps)

weight:
· 199 g (125cm)

features:
· Trail Pro Tape grip
· 1 spare tape included (solid blue)
· Fly Sport strap
· 3-sections:
Carbon Composite, Ø 16 mm
· FXP Folding system
· Trail UL basket
· Tungsten/Carbid tip

art. # 194 23 78-10

OutDoor
by SPPO
Outstanding Outdoor

+ OPTIONALLY AVAILABLE



spare tape included



packed size: 45 cm

FXP COMPOSITE TRAIL Pink

sizes:
· packed size: 45 cm (125 cm)
· 105-135cm (in 5cm steps)

weight:
· 199 g (125cm)

features:
· Trail Pro Tape grip
· 1 spare tape included (solid pink)
· Fly Sport strap
· 3-sections:
Carbon Composite, Ø 16 mm
· FXP folding system
· Trail UL basket
· Tungsten/Carbid tip

art. # 194 23 77-10

OutDoor
by SPPO
Outstanding Outdoor



FXP Tape, pre-packed

- art. # 8285-925 Black Pink Striped
- art. # 8288-925 Solid Pink
- art. # 8286-925 Black Green Striped
- art. # 8289-925 Solid Green
- art. # 8287-925 Black Blue Striped
- art. # 8290-925 Solid Blue

TREKKING

FX LITE



+ ADVANTAGES AT A GLANCE

- + Unfolds by itself – simply click and fix
- + As robust as a conventional telescopic pole due to multiple reinforced shafts
- + Easy and safe use
- + Foldable with press button



FX LITE CARBON Summit Vario

Sizes:
 • packed size: 40 cm
 • adjustable from 115–135 cm

Weight:
 • 236 g

Features:
 • Trek Pro 245 cork grip
 • Comfort Padded strap
 • 4-sections:
 Carbon, Ø 18/16 mm
 • Powerlock 3.0 locking mechanism
 • FX LITE folding mechanism
 • FXP UL VARIO basket
 • flex carbide tip

art. # 194 23 82-10



FX LITE CARBON Summit Vario Compact

Sizes:
 • packed size: 40 cm
 • adjustable from 105–125 cm

Weight:
 • 227 g

Features:
 • Trek Pro 245 cork grip
 • Comfort Padded strap
 • 4-sections:
 Carbon, Ø 18/16 mm
 • Powerlock 3.0 locking mechanism
 • FX LITE folding mechanism
 • FXP UL VARIO basket
 • flex carbide tip

art. # 194 23 83-10



TREKING

FX LITE

NO QUESTIONS ASKED
3
YEAR
SERVICE



FX LITE CARBON Approach Vario

Sizes:
· packed size: 40 cm
· adjustable from 115–135 cm

Weight:
· 241 g

Features:

- Trek Pro 245 Foam grip
- Comfort Padded strap
- 4-sections:
Aluminum 7075-T6, Ø 18 mm, Carbon, Ø 16 mm
- Powerlock 3.0 locking mechanism
- FX Lite folding mechanism
- FXP UL VARIO basket
- flex carbide tip

art. # 194 23 84-10

NO QUESTIONS ASKED
3
YEAR
SERVICE



FX LITE CARBON Approach Vario Compact

Sizes:
· packed size: 40 cm
· adjustable from 105–125 cm

Weight:
· 230 g

Features:

- Trek Pro 245 Foam grip
- Comfort Padded strap
- 4-sections:
Aluminum 7075-T6, Ø 18 mm, Carbon, Ø 16 mm
- Powerlock 3.0 locking mechanism
- FX Lite folding mechanism
- FXP UL VARIO basket
- flex carbide tip

art. # 194 23 85-10



NO QUESTIONS ASKED
3
YEAR
SERVICE

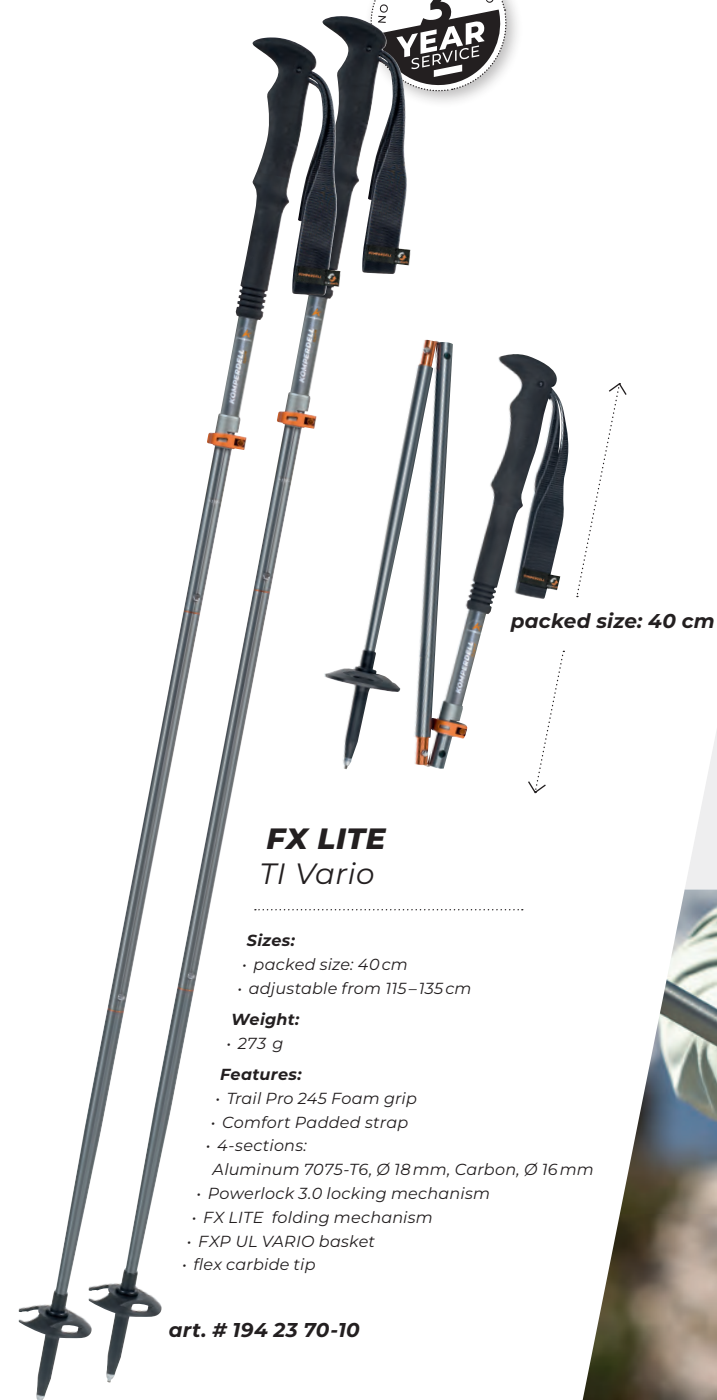

FX LITE TI Vario

Sizes:
· packed size: 40 cm
· adjustable from 115–135 cm

Weight:
· 273 g

Features:

- Trail Pro 245 Foam grip
- Comfort Padded strap
- 4-sections:
Aluminum 7075-T6, Ø 18 mm, Carbon, Ø 16 mm
- Powerlock 3.0 locking mechanism
- FX LITE folding mechanism
- FXP UL VARIO basket
- flex carbide tip

art. # 194 23 70-10

NO QUESTIONS ASKED
3
YEAR
SERVICE

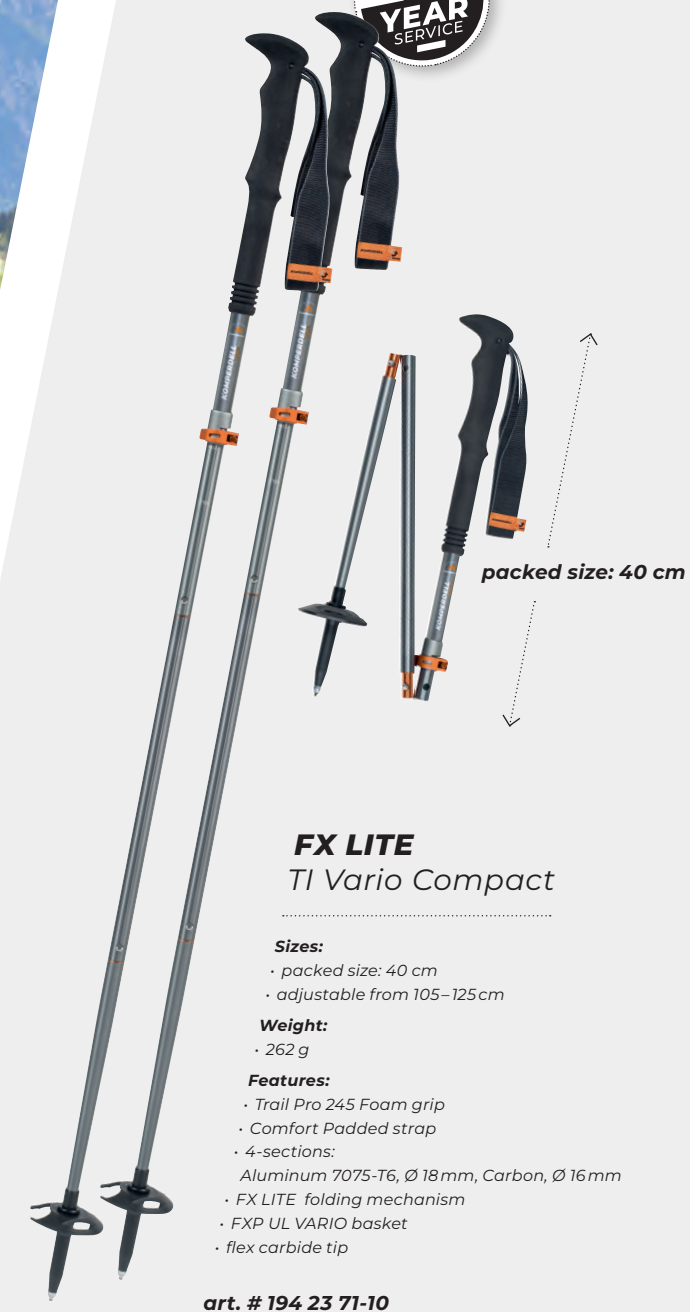

FX LITE TI Vario Compact

Sizes:
· packed size: 40 cm
· adjustable from 105–125 cm

Weight:
· 262 g

Features:

- Trail Pro 245 Foam grip
- Comfort Padded strap
- 4-sections:
Aluminum 7075-T6, Ø 18 mm, Carbon, Ø 16 mm
- FX LITE folding mechanism
- FXP UL VARIO basket
- flex carbide tip

art. # 194 23 71-10



WOMEN EDITION

Ladies' choice: a superior companion for your outdoor activities - trekking poles from our women edition. A perfect mix of design, fashion and highest functionality combined with lightness and a small packing size. A pole that offers all you could wish for!

**CALIMA**
Carbon**Sizes:**

- packed size: 57 cm
- adjustable from 90–120 cm

Weight:

- 179 g

Features:

- Trek Pro 280 cork grip
- Air Padded strap
- 3-sections:
Carbon ultralight, Ø 18/16/14 mm
- Powerlock 3.0 locking mechanism
- Mini UL Vario basket
- flex carbide tip

art. # 175 23 58-10

**WOMEN EDITION****BOREA**
Carbon Pro**Sizes:**

- packed size: 57 cm
- adjustable from 90–120 cm

Weight:

- 212 g

Features:

- Trek Pro 280 cork grip
- Air Padded strap
- 3-sections:
top part: Carbon, Ø 18 mm
middle part: Carbon, Ø 16 mm
lower part: Titanal .HF, Ø 14 mm
- Powerlock 3.0 locking mechanism
- Mini UL Vario basket
- flex carbide tip

art. # 175 23 59-10

**TRAMONTANA**
TI**Sizes:**

- packed size: 57 cm
- adjustable from 90–120 cm

Weight:

- 223 g

Features:

- Trek Pro 280 Foam grip
- Comfort Padded strap
- 3-sections:
Aluminum 7075-T6, Ø 18/16/14 mm
- Powerlock 3.0 locking mechanism
- Mini UL Vario basket
- flex carbide tip

art. # 174 23 59-55



CARBON ULTRA

Our Carbon Ultra trekking poles are a world champion in lightness and master every challenge.

CARBON ULTRA



CARBON ULTRA Zero

Sizes:

- packed size: 67 cm
- adjustable from 105–140 cm

Weight:

- 187 g

Features:

- Trek Pro 280 cork grip
- Air Padded strap
- 3-sections:
Carbon ultralight, Ø 18/16/14 mm
- Powerlock 3.0 locking mechanism
- Mini UL Vario basket
- flex carbide tip

art. # 175 23 85-10

ISPO
AWARD
2024
WINNER



POWERLOCK 3.0

200 kg vertical loading capacity – our Powerlock 3.0 offers by far the strongest holding force. The latest product update is consistently made of forged aluminum – unique and almost indestructible. **More power is not possible.**

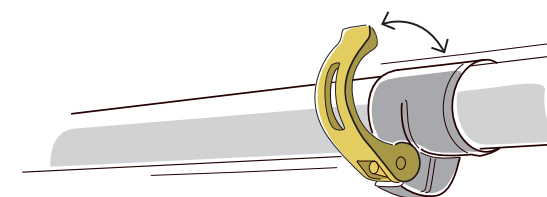

CARBON ULTRA Zero Compact

Sizes:

- packed size: 57 cm
- adjustable from 90–120 cm

Weight:

- 175 g

Features:

- Trek Pro 280 cork grip
- Air Padded strap
- 3-sections:
Carbon ultralight, Ø 18/16/14 mm
- Powerlock 3.0 locking mechanism
- Mini UL Vario basket
- flex carbide tip

art. # 175 23 86-10

ISPO
AWARD
2024
WINNER

CARBON PRO/EVO



packed size: 67 cm

CARBON PRO Zero

- Sizes:**
- packed size: 67 cm
 - adjustable from 105–140 cm

Weight:

- 218 g

Features:

- Trek Pro 280 Foam grip
- Comfort Padded strap
- 3-sections:
 - top part: Carbon, Ø 18 mm
 - middle part: Carbon, Ø 16 mm
 - lower part: Titanal.HF, Ø 14 mm
- Powerlock 3.0 locking mechanism
- Mini UL Vario basket
- flex carbide tip

art. # 175 23 87-10



packed size: 57 cm

CARBON PRO Zero Compact

- Sizes:**
- packed size: 57 cm
 - adjustable from 90–120 cm

Weight:

- 201 g

Features:

- Trek Pro 280 Foam grip
- Comfort Padded strap
- 3-sections:
 - top part: Carbon, Ø 18 mm
 - middle part: Carbon, Ø 16 mm
 - lower part: Titanal.HF, Ø 14 mm
- Powerlock 3.0 locking mechanism
- Mini UL Vario basket
- flex carbide tip

art. # 175 23 88-10

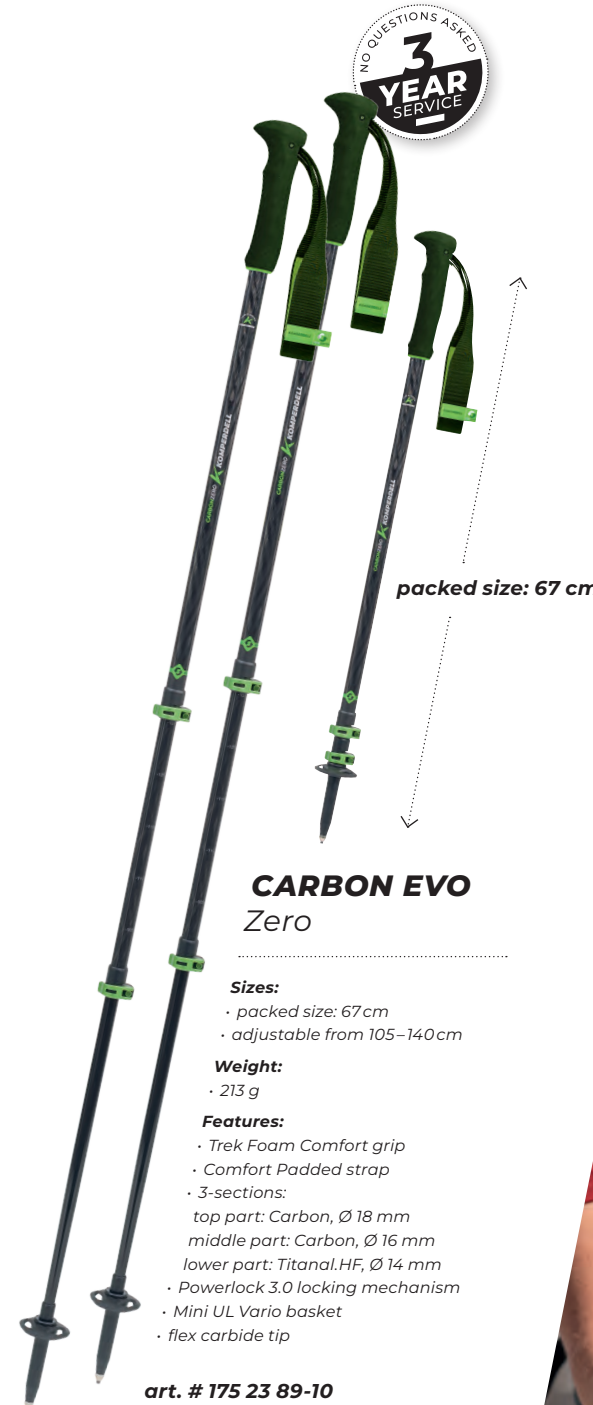

packed size: 67 cm

CARBON EVO Zero

- Sizes:**
- packed size: 67 cm
 - adjustable from 105–140 cm

Weight:

- 213 g

Features:

- Trek Foam Comfort grip
- Comfort Padded strap
- 3-sections:
 - top part: Carbon, Ø 18 mm
 - middle part: Carbon, Ø 16 mm
 - lower part: Titanal.HF, Ø 14 mm
- Powerlock 3.0 locking mechanism
- Mini UL Vario basket
- flex carbide tip

art. # 175 23 89-10



packed size: 57 cm

CARBON EVO Zero Compact

- Sizes:**
- packed size: 57 cm
 - adjustable from 90–120 cm

Weight:

- 193 g

Features:

- Trek Foam Comfort grip
- Comfort Padded strap
- 3-sections:
 - top part: Carbon, Ø 18 mm
 - middle part: Carbon, Ø 16 mm
 - lower part: Titanal.HF, Ø 14 mm
- Powerlock 3.0 locking mechanism
- Mini UL Vario basket
- flex carbide tip

art. # 175 23 90-10



TITANAL EXPLORER



EXPLORER Zero Cork

Sizes:
· packed size: 65 cm
· adjustable from 105–140 cm

Weight:
· 243 g

- Features:**
- Trek Pro 280 cork grip
 - Comfort Padded strap
 - 3-sections:
Aluminum 7075-T6, Ø 18/16/14 mm
 - Powerlock 3.0 locking mechanism
 - Mini UL Vario basket
 - flex carbide tip

art. # 174 23 60-10



EXPLORER Zero Cork Compact

Sizes:
· packed size: 57 cm
· adjustable from 90–120 cm

Weight:
· 226 g

- Features:**
- Trek Pro 280 cork grip
 - Comfort Padded strap
 - 3-sections:
Aluminum 7075-T6, Ø 18/16/14 mm
 - Powerlock 3.0 locking mechanism
 - Mini UL Vario basket
 - flex carbide tip

art. # 174 23 61-10



EXPLORER Zero

Sizes:
· packed size: 65 cm
· adjustable from 105–140 cm

Weight:
· 237 g

- Features:**
- Trek Pro 280 Foam grip
 - Comfort Padded strap
 - 3-sections:
Aluminum 7075-T6, Ø 18/16/14 mm
 - Powerlock 3.0 locking mechanism
 - Mini UL Vario basket
 - flex carbide tip

art. # 174 23 62-10

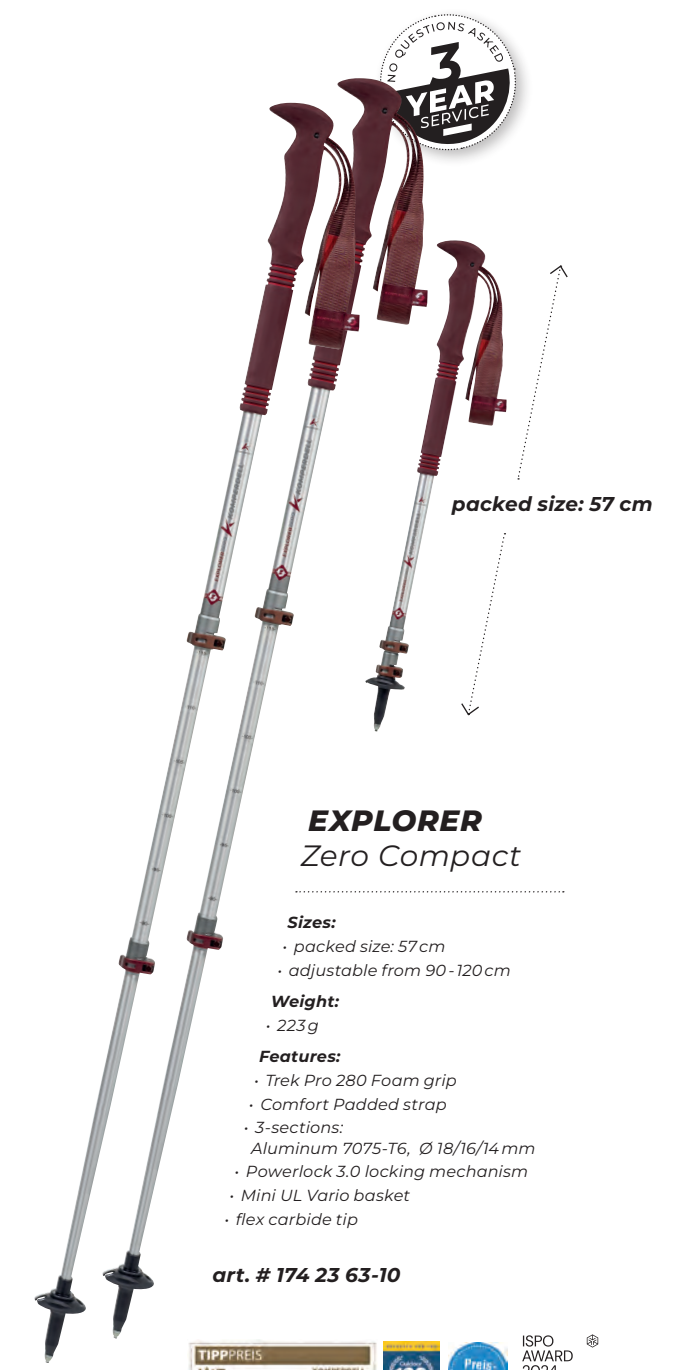

EXPLORER Zero Compact

Sizes:
· packed size: 57 cm
· adjustable from 90–120 cm

Weight:
· 223 g

- Features:**
- Trek Pro 280 Foam grip
 - Comfort Padded strap
 - 3-sections:
Aluminum 7075-T6, Ø 18/16/14 mm
 - Powerlock 3.0 locking mechanism
 - Mini UL Vario basket
 - flex carbide tip

art. # 174 23 63-10



RACING | BIG MOUNTAIN | JUNIOR | RENTAL | TOURING | SNOWSHOES | NORDIC XC | PROTECTION | TREKKING | NORDIC WALKING | ACCESSORIES

RACING | BIG MOUNTAIN | JUNIOR | RENTAL | TOURING | SNOWSHOES | NORDIC XC | PROTECTION | TREKKING | NORDIC WALKING | ACCESSORIES



TREKKING ALUMINUM



RIDGEHIKER Zero

Sizes:

- packed size: 64 cm
- adjustable from 105-140 cm

Weight:

- 269 g

Features:

- Trek cork Comfort grip
- Comfort Padded strap
- 3-sections: Aluminum 7075-T6, Ø 18/16/14 mm
- Powerlock 3.0 locking mechanism
- Mini UL Vario basket
- flex carbide tip

art. # 174 23 64-37

ISPO AWARD 2024 WINNER

Cork Grip
comfortable grip feeling

packed size: 64 cm

NO QUESTIONS ASKED 3 YEAR SERVICE

RIDGEHIKER Zero Compact

Sizes:

- packed size: 57 cm
- adjustable from 90-120 cm

Weight:

- 252 g

Features:

- Trek cork Comfort grip
- Comfort Padded strap
- 3-sections: Aluminum 7075-T6, Ø 18/16/14 mm
- Powerlock 3.0 locking mechanism
- Mini UL Vario basket
- flex carbide tip

art. # 174 23 65-29

ISPO AWARD 2024 WINNER

57 cm
7 cm smaller packed size

NO QUESTIONS ASKED 3 YEAR SERVICE



TREKKING ALUMINUM



packed size: 64 cm

TRAILMASTER Zero

- Sizes:**
- packed size: 64 cm
 - adjustable from 105-140 cm

Weight:

• 235g

Features:

- Trek Foam Comfort grip
- Comfort Padded strap
- 3-sections: Aluminum 7075-T6, Ø 18/16/14 mm
- Powerlock 3.0 locking mechanism
- Mini UL Vario basket
- flex carbide tip

art. # 174 23 66-06

ISPO AWARD 2024 WINNER



packed size: 57 cm

TRAILMASTER Zero Compact

- Sizes:**
- packed size: 57 cm
 - adjustable from 90-120 cm

Weight:

• 216 g

Features:

- Trek Foam Comfort grip
- Comfort Padded strap
- 3-sections: Aluminum 7075-T6, Ø 18/16/14 mm
- Powerlock 3.0 locking mechanism
- Mini UL Vario basket
- flex carbide tip

art. # 174 23 67-33

ISPO AWARD 2024 WINNER



packed size: 66 cm

HIGHLANDER Zero

- Sizes:**
- packed size: 66 cm
 - adjustable from 105-140 cm

Weight:

• 247g

Features:

- Trek cork Comfort grip
- Comfort Padded strap
- 3-sections: Aluminum 7075-T6, Ø 18/16/14 mm
- Twist Lock locking mechanism
- Mini UL Vario basket
- flex carbide tip

art. # 174 23 68-29

ISPO AWARD 2024 WINNER

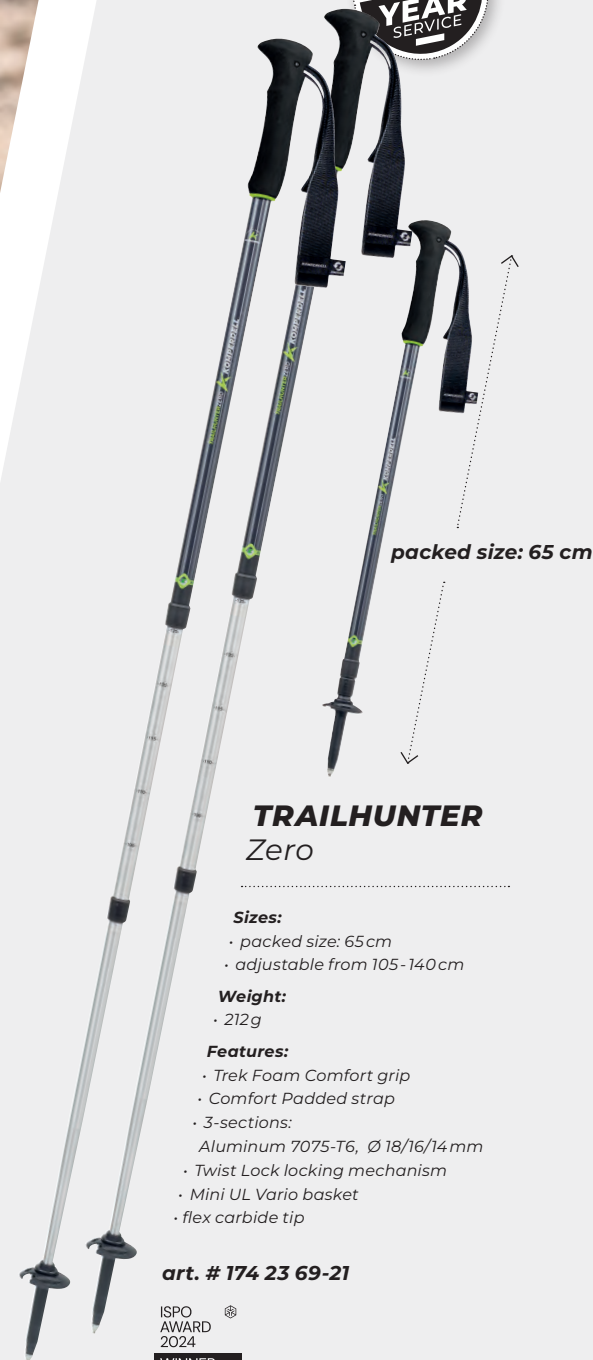

packed size: 65 cm

TRAILHUNTER Zero

- Sizes:**
- packed size: 65 cm
 - adjustable from 105-140 cm

Weight:

• 212g

Features:

- Trek Foam Comfort grip
- Comfort Padded strap
- 3-sections: Aluminum 7075-T6, Ø 18/16/14 mm
- Twist Lock locking mechanism
- Mini UL Vario basket
- flex carbide tip

art. # 174 23 69-21

ISPO AWARD 2024 WINNER

TREKKING JUNIOR

Let's go... straight into the adventure! Our junior trekking poles are not only made of extremely robust aluminum, they grow with the kids and the pole will stay a loyal companion over many years.



TREKKING JUNIOR

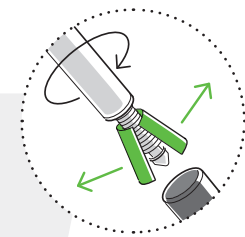

TWISTLOCK
made from glassfiber reinforced plastics

packed size: 65 cm



TRAILBLAZER Zero Kids

Sizes:
· packed size: 65 cm
· adjustable from 80-105 cm

Weight:
· 172 g

Features:
· Kids Tour cork grip
· standard strap
· 2-sections:
upper part: Aluminum 7075-T6, Ø 16 mm
lower part: Aluminum 5083, Ø 14 mm
· Twist Lock locking mechanism
· Mini UL Vario basket
· steel tip

■ art. # 164 23 20-48 green
■ art. # 164 23 21-14 pink



packed size: 74 cm

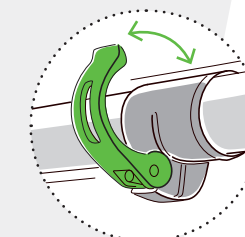

POWERLOCK 3.0
highly rigid, anodized aluminum for max. holding power!

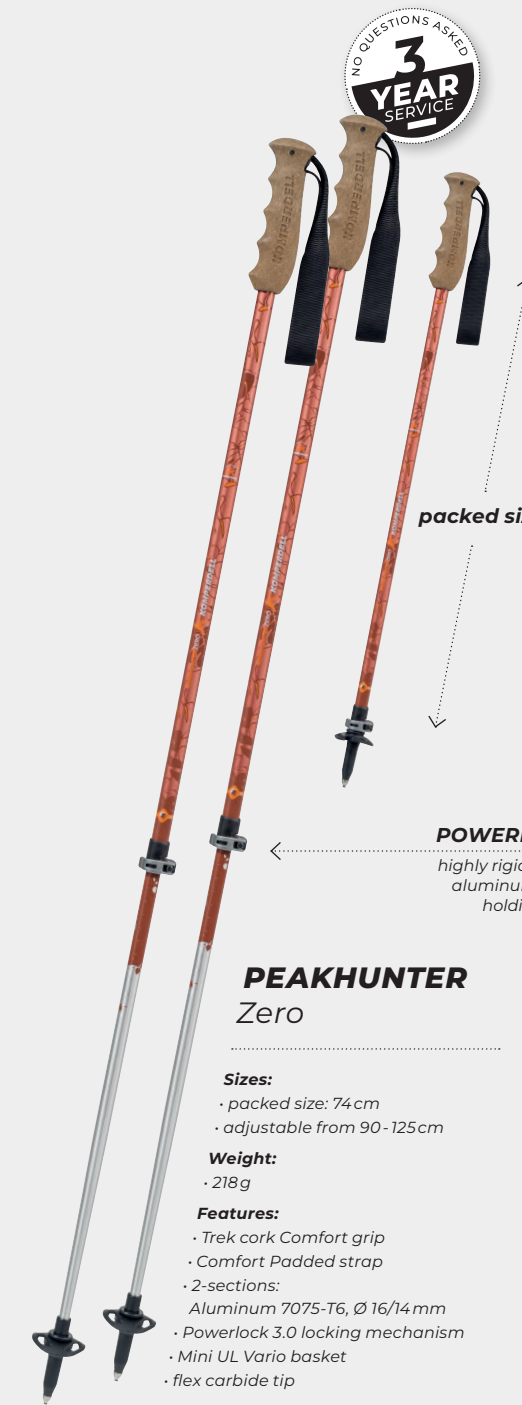

PEAKHUNTER Zero

Sizes:
· packed size: 74 cm
· adjustable from 90-125 cm

Weight:
· 218 g

Features:
· Trek cork Comfort grip
· Comfort Padded strap
· 2-sections:
Aluminum 7075-T6, Ø 16/14 mm
· Powerlock 3.0 locking mechanism
· Mini UL Vario basket
· flex carbide tip

art. # 164 23 19-29



RACING | BIG MOUNTAIN | JUNIOR | RENTAL | TOURING | SNOWSHOES | NORDIC XC | PROTECTION | TREKKING | NORDIC WALKING | ACCESSORIES

RACING | BIG MOUNTAIN | JUNIOR | RENTAL | TOURING | SNOWSHOES | NORDIC XC | PROTECTION | TREKKING | NORDIC WALKING | ACCESSORIES

TREKKING SINGLE STAFF



Camera Mount System
unscrew the head to mount your camera easily



neoprene quiver included

packed size: 45 cm

TRAVEL & WADING Staff FXP Vario

Sizes:
· packed size: 45 cm
· adjustable from 115-135 cm

Weight:
· 262 g

- Features:**
- Traveller 245 grip with Camera Mount System
 - Ergo strap
 - 4-sections: Carbon Composite, Ø 18/16 mm
 - Powerlock 3.0 locking mechanism
 - FXP folding mechanism
 - FXP UL Vario basket
 - flex carbide tip

art. # 196 23 05-10

Outdoor
by SPPO
Outstanding Outdoor
Gold Winner 2011



packed size: 36 cm

WALKING Staff FXP Carbon

Sizes:
· packed size: 36 cm (95 cm)
· 85/95/105 cm

Weight:
· 242 g (95 cm)

- Features:**
- Walker comfort cork grip
 - Walker strap
 - 3-sections: Carbon Composite, Ø 16/9 mm
 - FXP folding mechanism
 - Trailstick carbide tip
 - rubber tip protector

art. # 196 23 04-10

Outdoor
by SPPO
Outstanding Outdoor
Gold Winner 2011



Camera Mount System
unscrew the head to mount your camera easily



packed size: 73 cm

CAMERA Staff

Sizes:
· packed size: 73 cm
· adjustable from 115-150 cm

Weight:
· 294 g

- Features:**
- Traveller cork 380 grip with Camera Mount System
 - Ergo strap
 - 3-sections: Aluminum 7075-T6, Ø 18/16/14 mm
 - Powerlock 3.0 locking mechanism
 - FXP UL Vario basket
 - flex carbide tip

art. # 176 23 00-10



WALKING SINGLE STAFF

“Much more than just a walking aid. My Komperdell walking staff has, unlike my knee, never let me down. The ergonomically shaped cork grip keeps me grounded and offers a comfortable grip feeling.”

Johann Tuns, nature loving pensioner



TREKING
NORDIC WALKING
ACCESSORIES
PROTECTION
NORDIC XC
SNOWSHOES
TOURING
RENTAL
JUNIOR
BIG MOUNTAIN
RACING

WALKING SINGLE STAFF

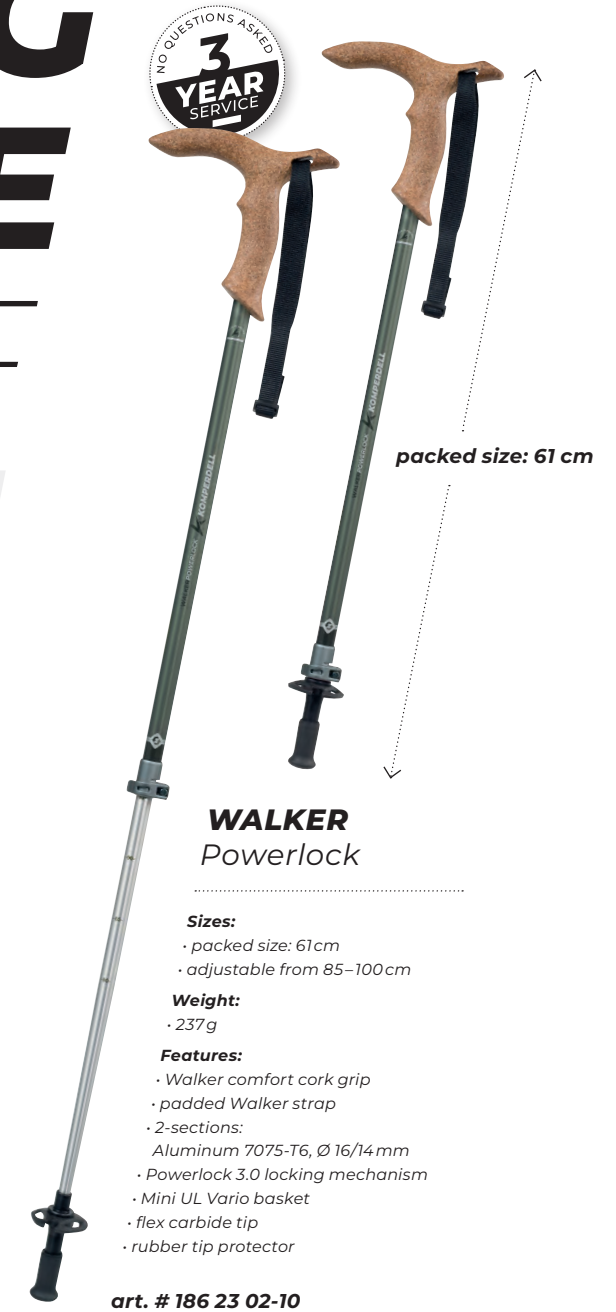

WALKER Powerlock

Sizes:
· packed size: 61 cm
· adjustable from 85–100 cm

Weight:
· 237 g

- Features:**
- Walker comfort cork grip
 - padded Walker strap
 - 2-sections:
Aluminum 7075-T6, Ø 16/14 mm
 - Powerlock 3.0 locking mechanism
 - Mini UL Vario basket
 - flex carbide tip
 - rubber tip protector

art. # 186 23 02-10



WALKER Powerlock Compact

Sizes:
· packed size: 46 cm
· adjustable from 75–100 cm

Weight:
· 259 g

- Features:**
- Walker comfort cork grip
 - padded Walker strap
 - 3-sections:
Aluminum 7075-T6, Ø 18/16/14 mm
 - Powerlock 3.0 locking mechanism
 - Mini UL Vario basket
 - flex carbide tip
 - rubber tip protector

art. # 176 23 74-10



TREKING
NORDIC WALKING
ACCESSORIES
PROTECTION
NORDIC XC
SNOWSHOES
TOURING
RENTAL
JUNIOR
BIG MOUNTAIN
RACING

NORDIC WALKING CARBON

With our ultra-light Nordic Walking carbon poles, your daily workout becomes pure pleasure.

RACING | BIG MOUNTAIN | JUNIOR | RENTAL | TOURING | SNOWSHOES | NORDIC XC | PROTECTION | TREKKING | NORDIC WALKING | ACCESSORIES



NORDIC WALKING CARBON



← Sheer bamboo veneer on carbon tube

LEVANTE Carbon

Sizes:
· 105-135cm (in 5cm steps)

Weight:
· 182 g (115 cm)

- Features:**
- Nordic cork Click-In 2.0 grip
 - NW Click-In 2.0 strap
 - Carbon Featherlight shaft, Ø 16/9mm
 - Trailstick carbide tip
 - vulcanised 2-K grip pad

- art. # 148 23 39-10 pure
- art. # 148 23 39-01 pearl

BAYAMO Carbon

Sizes:
· 105-135cm (in 5cm steps)

Weight:
· 173 g (115 cm)

- Features:**
- Nordic cork Click-In 2.0 grip
 - NW Click-In 2.0 strap
 - Carbon Featherlight shaft with Bamboo, Ø 16/9mm
 - Trailstick carbide tip
 - vulcanised 2-K grip pad

art. # 148 22 21-10



RACING | BIG MOUNTAIN | JUNIOR | RENTAL | TOURING | SNOWSHOES | NORDIC XC | PROTECTION | TREKKING | NORDIC WALKING | ACCESSORIES



NORDIC WALKING CARBON



CLICK-IN

Get in with a click and drop out with a push. Our new click-in system. **It couldn't be easier.**

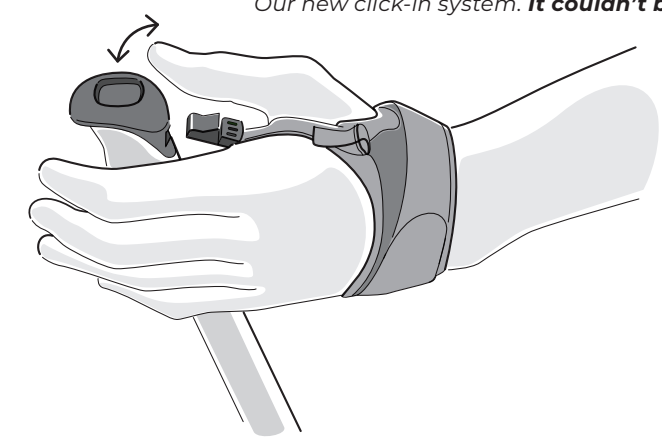

PONIENTE Carbon

- Sizes:**
- 105-135cm (in 5cm steps)
- Weight:**
- 196 g (115 cm)
- Features:**
- Nordic Foam Click-In grip
 - NW Click-In 2.0 strap
 - Carbon Composite, Ø 16/9 mm
 - Trailstick carbide tip
 - vulcanised 2-K grip pad

■ art. # 148 23 34-10 pure
□ art. # 148 23 34-01 pearl



FXP TRAVELLER Foldable

- Sizes:**
- packed size: 41 cm (115 cm)
 - 105-135 cm (in 10cm steps)
- Weight:**
- 212 g (115 cm)

- Features:**
- Nordic Foam Click-In grip
 - NW Click-In 2.0 strap
 - 3-sections: Carbon Composite, Ø 16 mm
 - FXP folding mechanism
 - Trailstick carbide tip
 - vulcanised 2K grip pad

art. # 194 23 58-10
Outdoor
by SPÖ



Outstanding Outdoor
www.spoe.com
© 2019 Spö

NORDIC WALKING VARIO



BAYAMO Carbon Vario

Sizes:
 • packed size: 98 cm
 • adjustable from 105 – 125 cm

Weight:
 • 182 g

Features:

- Nordic cork Click-In 2.0 grip
- NW Click-In 2.0 strap
- 2-sections:
Carbon, Ø 16/14 mm
- Powerlock 3.0 locking mechanism
- Trailstick carbide tip
- vulcanised 2-K grip pad

art. # 175 22 16-10



PONIENTE Carbon Vario

Sizes:
 • packed size: 98 cm
 • adjustable from 105 – 125 cm

Weight:
 • 182 g

Features:

- Nordic Foam Click-In grip
- NW Click-In strap 2.0
- 2-sections:
Carbon, Ø 16/14 mm
- Powerlock 3.0 locking mechanism
- Trailstick carbide tip
- vulcanised 2-K grip pad

art. # 175 23 62-10



SARMA Powerlock Black

Sizes:
 • packed size: 98 cm
 • adjustable from 105 – 125 cm

Weight:
 • 200 g

Features:

- Nordic Foam Click-In grip
- NW Click-In strap 2.0
- 2-sections:
Aluminum 7075-T6, Ø 16/14 mm
- Powerlock 3.0 locking mechanism
- Trailstick carbide tip
- vulcanised 2-K grip pad

art. # 184 23 87-10



SARMA Powerlock Pearl

Sizes:
 • packed size: 98 cm
 • adjustable from 105 – 125 cm

Weight:
 • 200 g

Features:

- Nordic Foam Click-In grip
- NW Click-In strap 2.0
- 2-sections:
Aluminum 7075-T6, Ø 16/14 mm
- Powerlock 3.0 locking mechanism
- Trailstick carbide tip
- vulcanised 2-K grip pad

art. # 184 23 87-01

ACCESSORIES

PRE-PACKED



NORDIC WALKING PADS

- art. # 1028-925
- art. # 1029-925



NORDIC WALKING PADS

- art. # 1007-203
- art. # 1007-01



FLY STRAP SPORT

Sizes:
· XS - XL
art. # 7040-925



FLY STRAP LOOP

Sizes:
· One Size
art. # 7031-925



TIP PROTECTOR

art. # 192-925 Ø 8 mm
art. # 190-925 Ø 12 mm



PACK-AWAY TIP

art. # 162-925 Ø 8 mm
art. # 161-925 Ø 12 mm



ERGO STRAP

art. # 7026-925



**NORDIC SPEED
CLICK IN 2.0 STRAP**

Sizes:
· S-XL
art. # 7017-925



**NORDIC WALKING
CLICK IN 2.0 STRAP**

Sizes:
· XS-L
art. # 7019-925



**NORDIC WALKING
CLICK IN 2.0 STRAP**

Sizes:
· XS-XL
art. # 7014-925



**TRAIL CLICK IN 2.1
STRAP**

Sizes:
· XS-XL
art. # 7018-925



**VARIO
SUMMER BASKET**

art. # 9356-925



RACE BASKET

art. # 9352-925



**RACE BASKET
EXTRA SMALL**

art. # 9379-925



TRAILSTICK BASKET

art. # 1022-925



**VARIO
WINTER BASKET**

art. # 9364-925



**VARIO
WINTER BASKET XL**

art. # 9912-925



**VARIO DEEP
POWDER BASKET**

art. # 9908-925



MINI UL BASKET

art. # 9942-925



**LARGE UL ICE-FLEX
BASKET**

art. # 9950-925



**REGULAR UL ICE-FLEX
BASKET**

art. # 9949-925



**REGULAR UL ICE-FLEX
FXP BASKET**

art. # 9952-925



REGULAR UL BASKET

art. # 9948-925



**MINI UL
VARIO BASKET**

art. # 9943-925



**REGULAR UL
VARIO BASKET**

art. # 9944-925



**LARGE UL
VARIO BASKET**

art. # 9951-925



**LARGE UL
VARIO BASKET**

art. # 9953-925

ACCESSORIES
NORDIC WALKING
TREKKING
PROTECTION
NORDIC XC
SNOWSHOES
TOURING
RENTAL
JUNIOR
BIG MOUNTAIN
RACING

ACCESSORIES
NORDIC WALKING
TREKKING
PROTECTION
NORDIC XC
SNOWSHOES
TOURING
RENTAL
JUNIOR
BIG MOUNTAIN
RACING

REPLACE- MENT BASKETS

Vario system:

Changing baskets within the vario system is possible.

Ice-flex system:

Ice-Flex baskets adapt up to 28° to the slope inclination. Changing baskets within the ice-flex system is possible.



**VARIO
SUMMER BASKET**

Ø 6 cm
art. # 9356



**VARIO
WINTER BASKET**

Ø 8,5 cm
art. # 9364



**VARIO
WINTER BASKET XL**

Ø 10 cm
art. # 9912



**VARIO
DEEP POWDER BASKET**

Ø 13,5 cm
art. # 9908



**MINI UL
VARIO BASKET**

Ø 5 cm
art. # 9943



**REGULAR UL
VARIO BASKET**

Ø 7 cm
art. # 9944



**REGULAR UL
VARIO FXP BASKET**

Ø 7 cm
art. # 9953



**LARGE UL
VARIO BASKET**

Ø 10,5 cm
art. # 9951

VARIO SYSTEM



RACE BASKET

Ø 6 cm
art. # 9352



**RACE BASKET
XS**

Ø 5 cm
art. # 9379



MINI UL BASKET

art. # 9942



**REGULAR UL
BASKET**

Ø 7 cm
art. # 9948



DOWNHILL BASKET

Ø 13,5 cm
art. # 9383

STANDARD SYSTEM



**LARGE UL
ICE-FLEX BASKET**

Ø 10,5 cm
art. # 9950



**XC SPEED
BASKET**

art. # 9384



ICE-FLEX-system
the simply brilliant moveable basket construction in combination with our ice-flex-tip



**TUBE-COLLAR FOR
ICE-FLEX SYSTEM**

art. # 147



**REGULAR UL
ICE-FLEX SYSTEM**

Ø 7 cm
art. # 9949



**REGULAR UL
ICE-FLEX FXP BASKET**

Ø 7 cm
art. # 9952

ICE-FLEX SYSTEM

ACCESSORIES
NORDIC WALKING
TREKKING
PROTECTION
NORDIC XC
SNOWSHOES
TOURING
RENTAL
JUNIOR
BIG MOUNTAIN
RACING

ACCESSORIES
NORDIC WALKING
TREKKING
PROTECTION
NORDIC XC
SNOWSHOES
TOURING
RENTAL
JUNIOR
BIG MOUNTAIN
RACING



ALPINE RACE STRAP

art. # 7304



POWDER STRAP

art. # 7350



PADDED STRAP

art. # 7342



LEATHER STRAP

Embossed logo

art. # 7313-2K



POWDER PADDED SCHLAUFE

art. # 7023



SIDEWINDER LOOP

art. # 7029-2k1



SIDEWINDER SPEED

art. # 7040-2k1



STANDARD STRAP ALPINE

art. # 7020 23mm



AUTOMATIC STRAP

art. # 7030 27mm



WALKER PADDES STRAP

art. # 7305



COMFORT / COMFORT PADDED STRAP

new loop system

art. # 7021 Comfort

art. # 722 Comfort Padded



FLY STRAP LOOP

art. # 7031-02



FLY STRAP SPORT

art. # 7040-02

STRAPS

NORDIC & NORDIC WALKING



NORDIC PADDED STRAP

art. # 7310



NORDIC CLASSIC STRAP

art. # 7331



**NORDIC SPEED
CLICK-IN 2.0 STRAP**

Sizes:
· S - M - L

art. # 7017



**NORDIC WALKING
CLICK-IN 2.0 STRAP**

Sizes:
· XS - S - M - L

art. # 7014



**TRAIL CLICK-IN 2.1
STRAP**

Sizes:
· XS - S - M - L

art. # 7018



VARIO PLUG

art. # 108



**ICE-FLEX TUNGSTEN/
CARBIDE TIP**

Ø 9 mm standard version

art. # 145



**VARIO TUNGSTEN/
CARBIDE FLEX TIP**

Ø 9 mm

art. # 178

art. # 99 for Powerlock



**VARIO TUNGSTEN/CARBIDE
FLEX TIP SHORT**

Ø 9 mm

art. # 193

art. # 174 for Powerlock



**NORDIC VARIO TUNGSTEN/
CARBIDE TIP**

Ø 9 mm

art. # 1015

FLEX-SPITZEN

ACCESSORIES / NORDIC WALKING / TREKKING / PROTECTION / NORDIC XC / SNOWSHOES / TOURING / RENTAL / JUNIOR / BIG MOUNTAIN / RACING

ACCESSORIES / NORDIC WALKING / TREKKING / PROTECTION / NORDIC XC / SNOWSHOES / TOURING / RENTAL / JUNIOR / BIG MOUNTAIN / RACING

TIPS FOR VARIO STANDARD BASKETS

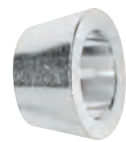

ALLOY PLUG

art. # 106



TUNGSTEN/CARBIDE FLEX TIP SHORT

Ø 9 mm

art. # 160



TUNGSTEN/CARBIDE FLEX STEEL TIP SHORT

Ø 9 mm

art. # 96



BASKET FIXING PLUG

art. # 101



TUBE COLLAR

art. # 100

NORDIC WALKER, NORDIC XC & TRAIL



TRAILSTICK TIP

Ø 9 mm with tungsten/carbide hollow tip

art. # 1022



TIP PROTECTOR

art. # 192 Ø 8 mm

art. # 190 Ø 12 mm



NORDIC WALKING CLASSIC COLOR PAD

Ø 12 mm black

art. # 1007-203



A BETEK BRAND



NORDIC/BC TOURING BASKET

with steel tip

art. # 9375



NORDIC TREK ULTRALIGHT BASKET

holebasket with tungsten/carbide tip

art. # 9941



NORDIC TRAIL ULTRALIGHT BASKET

Ø 9 mm with tungsten/carbide tip

art. # 9938



XC BASKET

with steel tip

art. # 9361

ADJUSTMENT MECHANISMS



POWERLOCK 3.0

art. # 1291 18/16 mm

art. # 1292 16/14 mm



POWERLOCK 2.1

art. # 1280 18/16 mm

art. # 1282 16/14 mm



TUBE COLLAR

art. # 1302 Ø 16 mm

art. # 1301 Ø 18 mm



THREADED PART

art. # 1209 Ø 14 mm

art. # 1207 Ø 16 mm



EXPANDING NUT

art. # 1210 Ø 14 mm

art. # 1208 Ø 16 mm



THREADED PART TITANAL.HF

art. # 1272 Ø 14 mm

art. # 1274 Ø 16 mm



EXPANDING NUT TITANAL.HF

art. # 1209 Ø 14 mm

art. # 1207 Ø 16 mm

ALPINE, TOURING & TREKKING GRIPS



LEATHERGRIP CLASSIC

art. # 8854 Ø 16 mm



RACE DUPLO GRIP

art. # 8073 Ø 12,3 mm

art. # 8079 Ø 13 mm

art. # 8549 Ø 16 mm



LIGHTNING DUPLO GRIP

art. # 8047 Ø 13 mm

art. # 8038 Ø 16 mm



LIGHTNING TOUR DUPLO GRIP

art. # 8101 Ø 13 mm

ACCESSORIES / NORDIC WALKING / TREKKING / PROTECTION / NORDIC XC / SNOWSHOES / TOURING / RENTAL / JUNIOR / BIG MOUNTAIN / RACING

ACCESSORIES / NORDIC WALKING / TREKKING / PROTECTION / NORDIC XC / SNOWSHOES / TOURING / RENTAL / JUNIOR / BIG MOUNTAIN / RACING



FOAM EXPEDITION SHORT GRIP

art. # 8010-02 Ø 18 mm
art. # 8166-02 Ø 20 mm



FOAM ALPINE GRIP

art. # 8784 Ø 18 mm



RACE GRIP

art. # 8321 PE Ø 18 mm
art. # 8179 rubber Ø 18 mm
art. # 8183 rubber Ø 13 mm
art. # 8180 PU Ø 18 mm



COMPACT GRIP SYSTEM

art. # 8214 PU Ø 13 mm
art. # 8239 PU Ø 18 mm
art. # 8256 PU Ø 19 mm
art. # 8241 PE Ø 18 mm
art. # 8238 rubber Ø 18 mm
art. # 8239-255 cork Ø 18 mm



AIRFOAM PISTOL

art. # 8926-02 Ø 13 mm
art. # 8927-02 Ø 16 mm
art. # 8928-02 Ø 18 mm



2K TOURING FOAM COMFORT

art. # 8410-212B Ø 13 mm
art. # 8411-212B Ø 16 mm
art. # 8413-212B Ø 18 mm



TREKKING FULL FOAM COMFORT

art. # 8420-208 Ø 13 mm

JUGEND & KIDS GRIPS



COMPACT GRIP STANDARD

art. # 8728 PE Ø 18 mm



WALKER COMFORT GRIP

art. # 8773-255 cork Ø 16 mm
art. # 8764-255 cork Ø 18 mm

RACEGRIP RUBBER LIME-GREEN

art. # 8264 Ø 16 mm
art. # 8818 Ø 18 mm
art. # 8233 Ø 19 mm



TREK 170 GRIP

art. # 8165 PE Ø 16 mm
art. # 8130-255 cork Ø 18 mm
art. # 8130-02 rubber Ø 18 mm



FOAM 280 GRIP

art. # 8159 Ø 16 mm
art. # 8135 Ø 18 mm



JUNIOR JET GRIP

art. # 8220 Ø 13 mm
art. # 8234 Ø 14 mm
art. # 8236 Ø 16 mm



JUNIOR GRIP

art. # 8206 PE Ø 14 mm
art. # 8734 PU Ø 16 mm



KIDS RACE GRIP

art. # 8182 PE Ø 14 mm
art. # 8181 PE Ø 16 mm
art. # 8320 PU Ø 16 mm

TOURING, NORDIC & NORDIC WALKING GRIPS



PISTOL 2K GRIP

art. # 8317 Ø 13 mm
art. # 8318 Ø 16 mm
art. # 8319 Ø 18 mm



2K TOURING FOAM 280 GRIP

art. # 8306-202A black/orange Ø 16 mm
art. # 8306-212B black/silver
art. # 8307-212B black/silver Ø 18 mm



2K TOURING FOAM 450 GRIP

art. # 8308-202A Ø 16 mm



FOAM PISTOL 120 GRIP

art. # 8313 Ø 13 mm
art. # 8314 Ø 16 mm



NORDIC 2K CLICK-IN 2.0 GRIP

art. # 8184 Ø 16 mm



NORDIC 2K CLICK-IN 2.0 GRIP

art. # 8177 Foam Ø 17 mm



XC GRIP

art. # 8721 Foam Ø 16 mm without Click-In
art. # 8738 Foam Ø 18 mm without Click-In



XC CLASSIC GRIP

art. # 8004-02 PE Ø 16 mm
art. # 8004-225 cork Ø 16 mm

ACCESSORIES

PRE-PACKED



PRE-PACKED

Information:

· Each pack contains two tapes of the selected colour

TRAILRUNNING TAPES



FXP Tape 21mm

- art. # 8292-925 Erbkönig Original
- art. # 8280-925 Erbkönig Green
- art. # 8282-925 Erbkönig Pink



FXP Tape 21mm

- art. # 8285-925 Black Pink Striped
- art. # 8288-925 Solid Pink
- art. # 8286-925 Black Green Striped
- art. # 8289-925 Solid Green
- art. # 8287-925 Black Blue Striped
- art. # 8290-925 Solid Blue

BIG ART TAPES



Tape Doodle 35mm

- art. # 8270-48 Doodle neon green
- art. # 8270-14 Doodle neon pink
- art. # 8270-999 Doodle multicolor



Tape Stripe 35mm

- art. # 8277-213 Stripe black/green
- art. # 8277-209 Stripe black/green
- art. # 8277-242 Stripe black/gold



Tape Full Colour 35mm

- art. # 8278-14 Full Colour pink
- art. # 8278-48 Full Colour green
- art. # 8278-02 Full Colour black



Tape Sprayed 35mm

- art. # 8275-213 Sprayed neon green/black
- art. # 8275-209 Sprayed neon pink/black
- art. # 8275-02 Sprayed black/black
- art. # 8275-211 Sprayed black/white
- art. # 8275-207 Sprayed black/blue



Tape Cheetah 35mm

- art. # 8279-02 Cheetah black/black
- art. # 8279-209 Cheetah black/pink
- art. # 8279-14 Cheetah pink/magenta
- art. # 8279-242 Cheetah gold/black

TAPE BOX Big Art

Features:
· box for 20 pairs tapes
art. # 6708-999



POS MATERIAL



PROTECTOREN SKI Cross Flex Demo Bord

- Features:**
- 60x78cm
 - Kapa material 5mm
 - removable protector insert
 - with optional hook to fix on cloth rail

art. # 6255-202



DISPLAY MANNEQUINS & TORSI

- Features:**
- lined transport bag
 - Base plate 18 x 30 x 0.6 cm for indoor and outdoor use
 - use Ground spike for outdoor use

- art. # 2080-99 Males mannequin
- art. # 2081-99 Ladies mannequin
- art. # 2082-99 Junior mannequin
- art. # 2083-99 Male torso
- art. # 2084-99 Female torso



DEMO BALLISTIC Vest on Torso

- Features:**
- technique of the Ballistic Vest
 - consists of torso, Ballistic

art. # 6254-206

PROTECTION Demo-Set

- Features:**
- Set of various protector demo inserts

art. # 6649-10



IMPACT TEST MACHINE Gondola single

- Features:**
- 1735x1700x625mm
 - power and individual air connection will be needed (oxygen tank possible)
 - incl. clothes rail for protectors

art. # 6544-10



MONITOR DISPLAY small 10 inch

- Features:**
- Space-saving display for corporate and product videos for a holistic and customer-friendly product presentation.

Size 24,5 x 16,9 CM
Resolution 1920 x 1080

art. # 6579-10



MONITOR DISPLAY big 15 inch

- Features:**
- Elegant display for company and product videos for a holistic and customer-friendly product presentation.

Size 34,1 x 27,3 cm
Resolution 1024x768

art. # 6580-10



POS MATERIAL



TEAM VEST Women

Sizes:
· XS - L

Features:
· innovative material-mix: extra-light shell material combined with smart breathable thermo-padding
· removeable hood stormproof

art. # 6345-02



TEAM WESTE Men

Sizes:
· XS - XL

Features:
· innovative material-mix: extra-light shell material combined with smart breathable thermo-padding
· removeable hood stormproof

art. # 6344-02



TEAM WEAR HOODY Men

Sizes:
· S - XXL

Features:
· individualization with own name or logo optional
· front zip

art. # K7801-208 neon green



TEAM WEAR HOODY Women

Sizes:
· S - XXL

Features:
· individualization with own name or logo optional
· front zip

art. # K6801-209 berry

BUFF BEANIE

Features:

- Reversible: two designs in one product.
- Ultra-Stretch Technology: 4-way stretch for best fit and maximum comfort.
- legendary comfort & top performance: recycled fiber, UV protection, improved elasticity.

art. # 6655-48 green

art. # 6656-14 pink



BUFF HEADBAND

Features:

- wide design for more comfort and protection
- Ultra-Stretch-Technology: 4-Way-Stretch for the best fit and comfort
- Recycled materials for a better planet

art. # 6653-48 green

art. # 6654-14 pink



BUFF MULTIFUNCTIONAL SCARF

Features:

- The multifunctional classic: flexible, recycled and providing UV-Protection
- Ultra-Stretch-Technology: 4-way-stretch for the best fit and comfort
- Enjoy multifunctionality: choose your style of wearing!

art. # 6659-48 green

art. # 6660-14 pink



POS MATERIAL



BLACK LIGHT PRESENTATION FOR NATIONALTEAM POLES

Features:

- 60W
- 1,5m cable length
- easy assembly
- consisting of lamp, mount, plug and remote
- appropriate for shop window, order fair, showrooms, highlight/product presentation

art. # 6456-10



DISPLAY Various athletes

Features:

- life-sized shop display
- real poles can be fixed on the display
- poles not included in the price

art. # 58-999



DISPLAY Race

Features:

- 169x48,5x78cm
- usable on both sides
- flexible arrangement of hooks possible
- includes 20 metal hooks
- robust and decorative
- space for 24 pairs of poles (products are not included)

art. # 58-999



BEACHFLAGS

Features:

- padded transportation bag
- base plate 18 x 30 x 0,6 cm for indoor use or bolt for outdoor use

total height 250 cm

■ art. # 34-48

■ art. # 34-123

total height 450 cm

■ art. # 29-48

■ art. # 29-123



POLE DISPLAY made of solid wood

for 16 pairs of poles (without poles)

art. # 6002-25

for 8 pairs of poles (without poles)

art. # 6001-25



POLE PACKAGING



POS MATERIAL



LOT BOX Zero Waste – Recycling

- Features:**
- 59x38.5x68 cm (measured without sticks)
 - In-store display for 15 pairs Telescopic or fixed length poles
 - made of robust cardboard
 - ideal for every shop
 - with recycling compartment for correct disposal

art. # 61-999

LOT BOX SMASH JUNIOR

- Features:**
- 59 x 86 x 36 cm (measured without poles)
 - Instore display for 25 pairs of Smash Series poles
 - made of cardboard
 - perfect for every shop

art. # 61-999



BIG ART Telescopic Lot Box

- Features:**
- 59x38.5x68 cm (measured without sticks)
 - In-store display for 25 pairs Telescopic poles
 - made of robust cardboard
 - ideal for every shop

art. # 6705-999



BIG ART Fixed Length Lot Box

- Features:**
- 59x38.5x68 cm (measured without sticks)
 - In-store display for 25 pairs fixed length poles
 - made of robust cardboard
 - ideal for every shop

art. # 6706-999



The best part of our quick and easy service is to always surprise our customers and exceed their expectations."

Stefanie, Stojadin and Claudia (customer service and repair department)



REPAIRING INSTEAD OF THROWING AWAY

Our commitment to sustainability goes beyond environmentally friendly production methods and recycled materials. We take after-sales responsibility seriously through our unique repair service.

INNOVATIVE PIONEERS

We introduced our free 3-year repair service more than 15 years ago, long before the term sustainability became popular. We are still absolute pioneers here today.

WORLDWIDE UNIQUE

We repair all telescopic poles no matter what happened – without receipt and no questions-asked. Regardless if it's our customers fault or ours – we are happy to take care of it and contribute to an extended product life-cycle and to protect our environment.



HEADQUARTERS MONDSEE

KOMPERDELL GmbH

Wagnermühle 30 | 5310 Mondsee | Austria
T 0043 6232 4201-0 | sales@komperdell.com
komperdell.com

DISTRIBUTION NORTH AMERICA

CAMARO USA, LLC

1021 | 39th Avenue SE Puyallup | WA 98374 | USA
T +1 253-867-57 35 | sales-usa@camaro.at
komperdell.com



KOMPERDELL