

A man in a blue and black ski jacket is climbing a snowy mountain slope. He is carrying skis on his back and using poles. He is smiling and looking towards the camera. The background is a vast, snowy mountain landscape.

**KOMPERDELL**

[www.komperdell.com](http://www.komperdell.com)

**WORKBOOK**  
**2022/23**

**3** YEAR  
SERVICE  
NO QUESTIONS ASKED

# 100% MADE IN AUSTRIA

WITH US YOU NOT ONLY KNOW WHERE YOUR POLE IS MADE BUT ALSO WHO IS STANDING BEHIND IT

*From the first concept to the finished product every single pole is made right in the heart of Austria. We are true innovators and for almost 100 years we stand for exceptional quality, outstanding service and honest sustainability.*



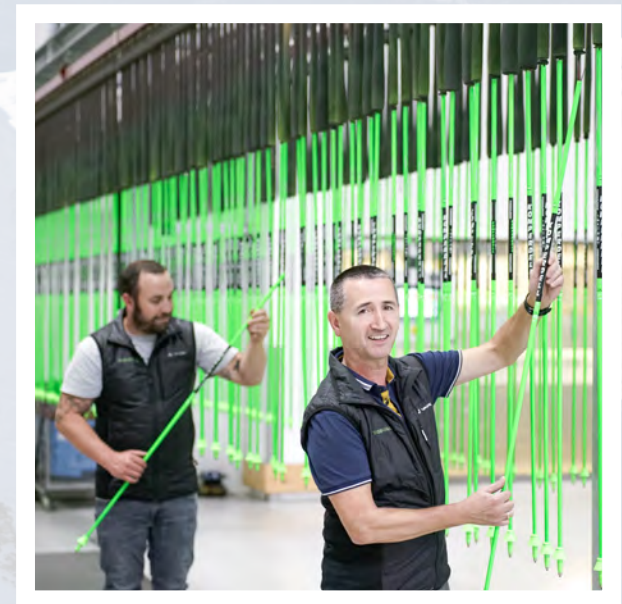

## INNOVATION

*We are pioneers, trendsetters and true innovators in poles, protection and snowshoes.*

*In each and every product we invest a lot of heart and soul to constantly surprise and excite our customers.*

*Our products have won more than 30 international awards. An honour that constantly motivates us to strive to do better with every new product we create.*



## QUALITY

*Above all, there is a lot of personal pride and passion of each and every one of our employees in every single product we create.*

*Exciting and surprising our customers with what we do means the world to us.*

*Premium products deserve premium service. Therefore every KOMPERDELL product is backed by our 3-year „no questions asked“ repair service.*

## HONEST SUSTAINABILITY

*Our new factory is really state of the art. Our machinery and filtration systems are designed to keep our environmental impact down to an absolute minimum.*

*Today, we certainly run the world's cleanest pole factory. Honest sustainability is not a slogan but a true commitment from every one of us.*

# RACING WORLD CUP



**MARCO SCHWARZ**  
WORLD CHAMPION IN COMBINATION  
4 VICTORIES IN WORLD CUP RACES



© GEPA-PICTURES

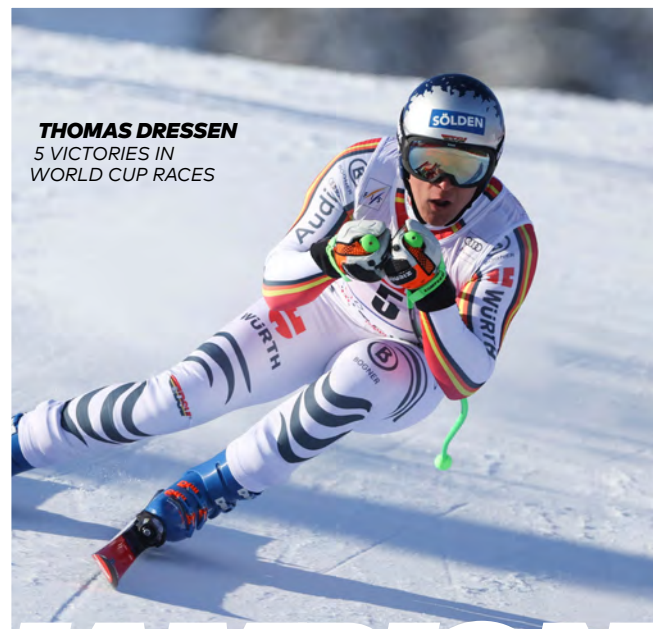

**THOMAS DRESSEN**  
5 VICTORIES IN  
WORLD CUP RACES



**PETRA VLHOVA**  
GIANT SLALOM WORLD CHAMPION  
OVERALL WORLD CUP WINNER  
SLALOM WORLD CUP WINNER  
2-TIMES PARALLEL WORLD CUP WINNER

# CHAMPION'S CHOICE

MORE THAN 200 ATHLETES TRUST IN OUR PRODUCTS

We are one of the most successful racing brands in history. The world's best skiers have sworn by our equipment for decades.

**SOLID SCREW JOINT**  
for extra tight fit and no twisting of the punch protection

**PUNCH PROTECTION**  
made of highly resistant thermoplastic resin, absorbs hard impacts

**STRAP FASTENING**  
makes tearing off the strap nearly impossible

**SKICROSS STRAP**  
with free hands at the starting block catapulted into the race

**SHRINKING TUBE**  
for reinforcement of the tube

**WORLD CUP EQUIPMENT**  
extremely rigid materials and precise manufacturing for highest demands

**CARBON SHAFTS**  
for zero weight and maximum performance



**NATIONALTEAM  
CARBON SLALOM 12,3**

**Sizes:** 100 - 140 cm  
(in 5 cm steps)

- Features:**
- \* technical grip with rubber & punch cover World-Cup style
  - \* race strap
  - \* carbon, Ø 12,3 mm
  - \* mini race basket
  - \* flex carbide RACE tip

art. # 147 32 51-48



**NATIONALTEAM  
CARBON GS 12,3**

**Sizes:** 105 - 140 cm  
(in 5 cm steps)

- Features:**
- \* race grip Duplo
  - \* race strap
  - \* carbon, Ø 12,3 mm
  - \* downhill basket
  - \* flex carbide RACE tip

art. # 147 32 54-48



**NATIONALTEAM CARBON  
SKICROSS 12,3 MM**

**Sizes:** 105 - 140 cm  
(in 5 cm steps)

- Weight:** 189 grams(125cm)
- Features:**
- \* X-Trail click-in foam grip
  - \* skicross strap
  - \* carbon, Ø 12,3 mm
  - \* mini race basket
  - \* flex carbide RACE tip

art. # 147 32 55-48

**BASKETS & TIPS**  
fixed with special glue for extra strong holding force

# RACING WORLD CUP



**VINCENT KRIECHMAYR**  
WORLD CHAMPION DOWNHILL  
WORLD CHAMPION SUPER-G  
9 VICTORIES IN WORLD CUP RACES

© GEPA-PICTURES

**RACE GRIP**  
offers perfect grip and  
secure grip feeling



**NATIONALTEAM  
CARBON GS BENT**

**Sizes:** 115 - 140 cm  
(in 5 cm steps)

**Features:**

- \* race grip Duplo
- \* race strap
- \* carbon, Ø 16/10 mm, bent
- \* downhill basket
- \* flex carbide RACE tip

art. # 148 10 54-48



**NATIONALTEAM  
CARBON SUPER-G**

**Sizes:** 120 - 140 cm  
(in 5 cm steps)

**Features:**

- \* race grip Duplo
- \* race strap
- \* carbon, Ø 16/10 mm, bent
- \* downhill basket
- \* flex carbide RACE tip

art. # 148 10 52-48

**BENT CARBON**  
with aerodynamic bend  
for maximum speed



**NATIONALTEAM  
CARBON DOWNHILL**

**Sizes:** 120 - 140 cm  
(in 5 cm steps)

**Features:**

- \* race grip Duplo
- \* race strap
- \* carbon, Ø 16/10 mm, bent
- \* downhill basket
- \* flex carbide RACE tip

art. # 148 10 53-48



**NATIONALTEAM  
PROFI 19MM**

**Sizes:** 100 - 135 cm  
(in 5 cm steps)

**Features:**

- \* race grip Duplo
- \* race strap
- \* aluminum 7075-T6, Ø 19 mm
- \* mini race basket
- \* flex carbide RACE tip

art. # 144 42 01-48

# RACING CARBON



*Henrik Kristoffersen*

**HENRIK KRISTOFFERSEN**

WORLD CHAMPION GIANT SLALOM  
2-TIME SLALOM WORLD CUP WINNER  
GIANT SLALOM WORLD CUP WINNER  
2 OLYMPIC MEDALS  
3 VICTORIES WORLD CUP RACES



**HIGH PERFORMANCE CARBON**  
 We develop our own carbon tubes. Top-quality japanese carbon fibers in combination with our unique production technique and resins result in top quality carbon poles with breaking points up to 200 kg's.



**NATIONALTEAM CARBON**

**Sizes:** 110 - 135 cm  
 (in 5 cm steps)

**Features:**

- \* race grip Duplo
- \* powder strap
- \* carbon, Ø 13/9mm
- \* mini race basket
- \* tungsten/carbide flex tip

art. # 146 42 01-48



length 85 - 95 cm  
**Kids Race Grip**

length 100 - 115 cm  
**Junior Race Grip**

**JUNIOR-EDITION**

The perfect racing pole made of extra light carbon for tomorrow's winner!



**NATIONALTEAM CARBON JUNIOR**

**Sizes:** 85 - 115 cm  
 (in 5 cm steps)

**Features:**

- \* Kids Race grip (length 85 - 95 cm) / Junior Race grip (length 100 - 115 cm)
- \* powder strap
- \* carbon, Ø 13/9mm
- \* mini race basket
- \* tungsten/carbide flex tip

art. # 146 42 02-48

**POWDER STRAP**

easy to adjust for perfect fit and comfort

# RACING ALUMINUM



**WORLD CUP**  
\*\*\*\*\*

## NATIONALTEAM J SLALOM 19 MM

**Lengths:** 100 - 135 cm  
(in 5 cm steps)

**Features:**

- \* technical grip with rubber & punch cover World-Cup style
- \* race strap
- \* aluminum 7075-T6, Ø 19 mm
- \* lining disc basket, fixed with alu fitting and tube collar
- \* tungsten/carbide tip

art. # 144 42 51-48



**WORLD CUP**  
\*\*\*\*\*

## NATIONALTEAM PROFI 19 MM

**Lengths:** 100 - 135 cm  
(in 5 cm steps)

**Features:**

- \* race rubber grip
- \* race strap
- \* aluminum 7075-T6, Ø 19 mm
- \* mini race basket
- \* tungsten/carbide tip

art. # 144 42 01-48



**ALICE ROBINSON**  
3 VICTORIES IN WORLD CUP RACES



**POWDER STRAP**  
easy to adjustment  
for perfect fit  
and comfort

**SUPER-G POLE**  
made of extremely strong  
aluminum 7075-T6 with  
aerodynamical Super-G  
bending

**HIGH-END ALUMINUM**  
Ingredients of zinc and magnesium  
together with a complex alloying  
technique result in extreme  
strength, similar to steel.

**NATIONALTEAM  
SUPER-G 18 MM**

**Sizes:** 110 - 135 cm  
(in 5 cm steps)

**Features:**

- \* rubber race grip
- \* powder strap
- \* aluminum 7075-T6, Ø 18 mm
- \* downhill basket
- \* tungsten/carbide flex tip

art. # 134 42 02-48



**NATIONALTEAM  
18 MM**

**Sizes:** 110 - 135 cm  
(in 5 cm steps)

**Features:**

- \* rubber race grip
- \* powder strap
- \* aluminum 7075-T6, Ø 18 mm
- \* mini race basket
- \* steel tip

art. # 134 42 01-48



**NATIONALTEAM  
SUPER-G JUNIOR**

**Sizes:** 85 - 115 cm  
(in 5 cm steps)

**Features:**

- \* Kids race grip (length 85 - 95 cm) / Junior race grip (length 100 - 115 cm)
- \* powder strap
- \* Alu 7075-T6, Ø 16 mm
- \* downhill basket
- \* flex carbide tip

art. # 224 42 02-48



**JUNIOR-EDITION**  
Nationalteam poles made of  
extremely strong aluminum for  
true Worlcup feeling!

**NATIONALTEAM  
JUNIOR**

**Sizes:** 85 - 115 cm  
(in 5 cm steps)

**Features:**

- \* Kids race grip (length 85 - 95 cm) / Junior race grip (length 100 - 115 cm)
- \* powder strap
- \* aluminum 7075-T6, Ø 16 mm
- \* mini race basket
- \* flex carbide tip

art. # 224 42 01-48

# PROTECTION CARBON



**INCLUSIVE  
TRANSPORT BAG**

**LEADING EDGE**  
provides perfect stability



**CUSTOMIZED FIT**  
provides perfect  
close fitting

**CARBON SHINGUARD  
WORLD CUP**

art. # 6535-48



**REINFORCED SURFACE**  
provides perfect protection  
for the full length of the shin

**FLEXIBLE  
OUTER EDGE**  
to adjust to  
every shape

**SHORTEN TO  
INDIVIDUAL LENGTH**  
to fit every ski boot



**INDIVIDUALLY  
ADAPTABLE**

close fitting  
with the boot



**CARBON SHINGUARD  
WORLD CUP UNCUT**

art. # 6538-48

**REINFORCED MATERIAL IN THE CENTER**  
perfect protection from hitting the gates

**FLEXIBLE OUTER EDGE**  
to adjust to every shape



**CARBON ELBOW PROTECTION**  
**WORLD CUP**

art. # 6537-48

**INDIVIDUALLY ADAPTABLE**



**RIVETS AND STRAPS**  
for your optimal position and best hold



**CARBON ELBOW GUARD**  
**WORLD CUP UN CUT**

art. # 6539-48

# RACING PROTECTION



**SEBASTIAN-FOSS SOLEVÅG**  
WORLD CHAMPION SLALOM  
1 VICTORY IN A WORLD CUP RACE



**SEAMS AT THE OUTSIDE**  
no irritating seams  
on your fingertips

**NON-SLIP PALM**  
for best grip

**EXPANDED  
KNUCKLE  
PROTECTION**  
made of Carbon

**RACING GLOVE**

Sizes: XS - XL

**Features:**

- \* real leather
- \* special thermal insulation
- \* knuckle protection made of carbon
- \* shock absorbing foam at finger, thumb and back of the hand

art. # 6501-02

**PADDING IN  
ARMADILLO PRINCIPLE**  
flexible punch protection



extremely warm &  
genuine leather

**IMPACT  
PROTECTION**

**TOUGH-STUFF MATERIAL**  
extremely abrasion  
resistant – also used  
in motorcycling

**RACING LOBSTER**

Sizes: XS - XL

**Features:**

- \* real leather
- \* special thermal insulation
- \* knuckle protection made of carbon
- \* shock absorbing foam at finger, thumb and back of the hand

art. # 6502-02



**SHIN GUARD  
PROFI WORLD CUP**

art. # 747-48 Adult

art. # 151-48 Junior



**PUNCH PROTECTION  
WORLD CUP**

■ art. # 156-48

■ art. # 156-02



**PUNCH PROTECTION  
PROFI**

■ art. # 158-48

■ art. # 158-02



**PUNCH PROTECTION  
BIG**

■ art. # 153-48



**PUNCH PROTECTION  
SMALL**

■ art. # 152-48



**ELBOW PROTECTION  
WORLD CUP**

art. # 130-48 Adult

art. # 129-48 Junior

**RACING  
PROTECTION**







ALSO FOR  
YOUNG RIDERS

SIZE CHART  
FOR JUNIORS

| size | unisex | age      |
|------|--------|----------|
| 116  | XS     | 6 years  |
| 128  | S      | 8 years  |
| 140  | M      | 10 years |
| 152  | L      | 12 years |

PROTECTOR



BREATHABLE  
COMFORT LAYER



PROTECTION  
OF FOREARM



PROTECTION OF THIGH

PROTECTION OF KNEE

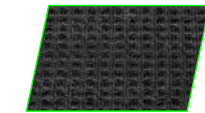

EXTRA WARM  
extra warm due to thermo fleece lining

FULL PROTECTOR  
RACE SUIT

Sizes: Adult: XXS - XXL  
Junior: 116 - 152

Features:

- \* with integrated protector at the back
- \* special racing material
- \* elastic and breathable
- \* integrated protectors at upper arms, forearms, shoulders, hips, tailbone, thigh & knee
- \* preshaped cut – adapted to the racing position
- \* thumb-loops
- \* front zip

art. # 6307-02 Adult  
art. # 6308-02 Junior

PROTECTION OF  
SHOULDER BLADE & BACK



4-WAY STRETCH MATERIAL  
for highest resistance  
and flexibility



ELASTIC

# RACING PROTECTION



**LUCA AERNI**  
WORLD CHAMPION  
IN COMBINATION

**PROTECTOR**

**PROTECTION OF SHOULDERS**

**EXTRA WARM**  
extra warm due to thermo fleece lining

**ALSO FOR YOUNG RIDERS**

| SIZE CHART FOR JUNIORS |        |          |
|------------------------|--------|----------|
| size                   | unisex | age      |
| 116                    | XS     | 6 years  |
| 128                    | S      | 8 years  |
| 140                    | M      | 10 years |
| 152                    | L      | 12 years |

**BREATHABLE COMFORT LAYER**

**PROTECTION OF FOREARM**

**PROTECTION OF THIGH**

**PROTECTION OF KNEE**

**4X ELASTIC**  
**4-WAY STRETCH MATERIAL**  
for highest resistance and flexibility

**PROTECTION OF TAILBONE**

**SLALOM RACE SUIT**

**Sizes:** Adult: XXS - XXL  
Junior: 116 - 152

**Features:**

- \* integrated protectors at upper arms, forearms, shoulders, hips, tailbone thigh & knee
- \* special racing material
- \* elastic and breathable
- \* preshaped cut - adapted to the racing position
- \* thumb-loops
- \* front zip
- \* perfect combination with FIS Approved Flex Pack

art. # 6303-02 Adult  
art. # 6304-02 Junior

# RACING PROTECTION





MEETS  
FIS REGULATIONS

**BACK PROTECTION**  
multilayer Cross 6.0 protector  
for perfect protection

## FLEX PACK

**Sizes:** Adult: XXS - XL  
Junior: 128 - 140 - 152

### Features:

- \* multilayer Cross Flex back-protector made of adaptive dual-density foam, EN-approved 1621-2
- \* conforms to FIS regulations
- \* anatomic shaped back part
- \* new preshaped strap system for best fit – shoulder it like a backpack
- \* protector insert visible - part of the design concept
- \* ultimate freedom of movement
- \* slim kidney belt for perfect fit, adjustable with velcro and plush

art. # 6362-213 Adult  
art. # 6363-213 Junior

## FULL PROTECTOR SLALOM SHIRT LONG

**Sizes:** Adult: XS - XL  
Junior: 116 - 152

### Features:

- \* perfect breathability, comfortable to wear
- \* multilayer Cross 6.0 back-protector, made of adaptive dual-density foam, EN-approved 1621-2
- \* perfect protection of back, shoulders, shoulderblades & arms

art. # 6301-208 Adult  
art. # 6302-208 Junior

## PROTECTOR SLALOM SHIRT

**Sizes:** Adult: XS - XL  
Junior: 116 - 152

### Features:

- \* perfect breathability, comfortable to wear
- \* body-shape cut
- \* multilayer protectors made of dual-density foam
- \* perfect protection of shoulders, shoulderblades and arms
- \* specially shaped back for perfect combination with the Fis approved Flex Pack

art. # 6283-02 Adult  
art. # 6284-02 Junior



**SEVERAL COMPARTMENTS**  
with partitions for goggles, helmet and punch guards



**WATERPROOF BOTTOM-CONSTRUCTION**

**SIDE POCKETS**  
to store ski-boots or other accessories

## NATIONALTEAM SKI BOOT BAG

### Features:

- \* Ski-boots to be stored either in the main compartment or in the side pockets (dry compartment)
- \* partitions in the main compartment (e.g. for helmet, goggles, punch guards)
- \* adjustable and padded shoulder-straps, straps for chest and waist
- \* back-straps can be stowed away
- \* waterproof bottom construction
- \* measurements 600x500x350 mm
- \* total volume 72 liters

art. # 6503-208



**BACK-STRAP SYSTEM**  
can be stowed away

## NATIONALTEAM EXPANDABLE POLE & SKI BAG

### Features:

- \* capacity for 4 pair of skis plus poles
- \* integrated straps with non-slip fixing
- \* tear-proof and robust
- \* total length 1500 mm / 109.2 liters
- \* expandable on both ends for 35 cm to a total of 2200 mm / 160.16 liters

art. # 6414-02



expandable on both ends  
(length of 220 cm possible  
up to 35cm)

personalization  
is optional

## NATIONALTEAM EXPANDABLE POLE & SKI BAG WITH WHEELS

### Features:

- \* capacity for 4 pair of skis plus poles
- \* integrated straps with non-slip fixing
- \* reinforced and padded bottom
- \* integrated wheels
- \* carry-system can be adjusted to the individual center of gravity
- \* total length 1500 mm / 109.2 liters
- \* expandable in length for 70 cm to 220 cm / 60.16 liters
- \* packed size 75 cm

art. # 6500-02

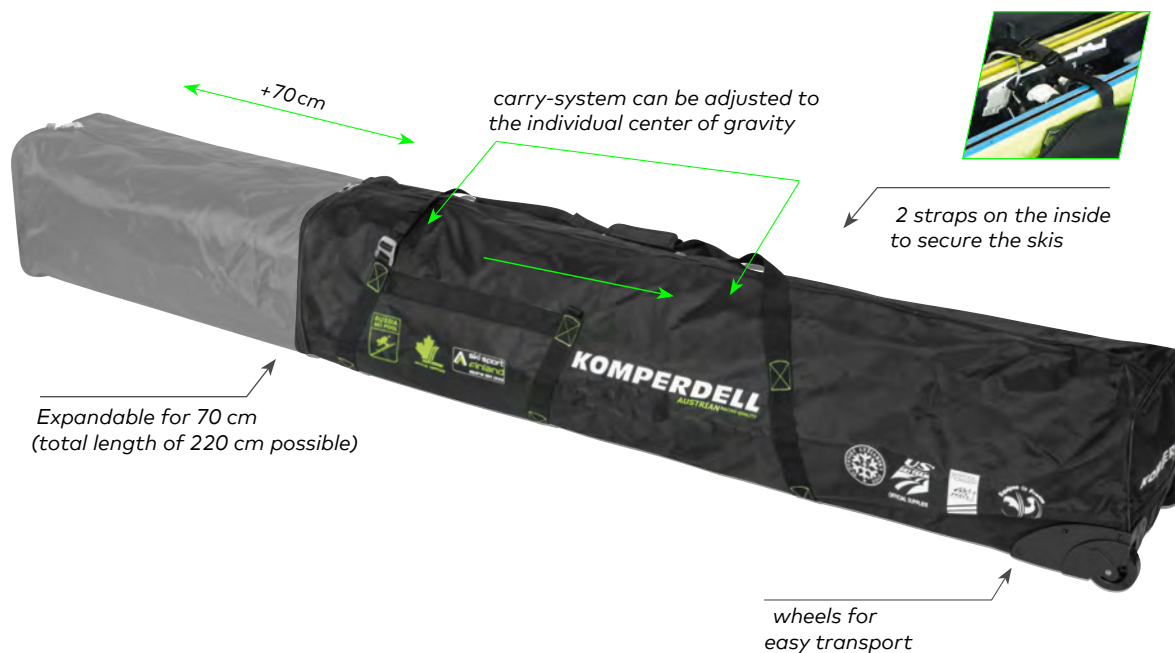

Expandable for 70 cm  
(total length of 220 cm possible)

wheels for  
easy transport

# ALPINE CHAMPION







### CARBON CHAMPION GREEN HENRIK

**Sizes:** 110 - 135 cm  
(in 5 cm steps)

**Weight:** 201 grams (125 cm)

**Features:**

- \* race grip rubber
- \* Comfort Strap
- \* carbon, Ø 13 mm
- \* mini race basket
- \* flex steel tip

art. # 146 23 28-10



### CARBON CHAMPION PINK ALICE

**Sizes:** 110 - 135 cm  
(in 5 cm steps)

**Weight:** 201 grams (125 cm)

**Features:**

- \* race grip rubber
- \* Comfort Strap
- \* carbon, Ø 13 mm
- \* mini race basket
- \* flex steel tip

art. # 146 23 29-10



### CHAMPION GREEN HENRIK

**Sizes:** 110 - 135 cm  
(in 5 cm steps)

**Weight:** 212 grams (125 cm)

**Features:**

- \* race grip rubber
- \* Comfort Strap
- \* aluminum 5083, Ø 18 mm
- \* mini race basket
- \* steel tip

art. # 132 22 36-02



### CHAMPION PINK ALICE

**Sizes:** 110 - 135 cm  
(in 5 cm steps)

**Weight:** 212 grams (125 cm)

**Features:**

- \* race grip rubber
- \* Comfort Strap
- \* aluminum 5083, Ø 18 mm
- \* mini race basket
- \* steel tip

art. # 132 22 37-02

# ALPINE BAMBOO



GRIP MADE OF GENUINE LEATHER

3  
YEAR  
SERVICE  
NO QUESTIONS ASKED

SHEER BAMBOO VENEER  
on carbontube



**POWERLOCK 3.0**  
highly rigid, anodized  
aluminum for maximum  
holding power!

## CARBON CLOUD BAMBOO VARIO

**Sizes:** adjustable from 110 - 145 cm

**Weight:** 199 grams

**Features:**

- \* leather grip
- \* leather strap with embossed logo
- \* 2-sections:
  - upper part: carbon enhanced with bamboo, Ø 16 mm
  - lower part: carbon, Ø 14 mm
- \* Powerlock 3.0 mechanism
- \* regular UL basket
- \* Vario flex carbide tip

art. # 175 22 15-10

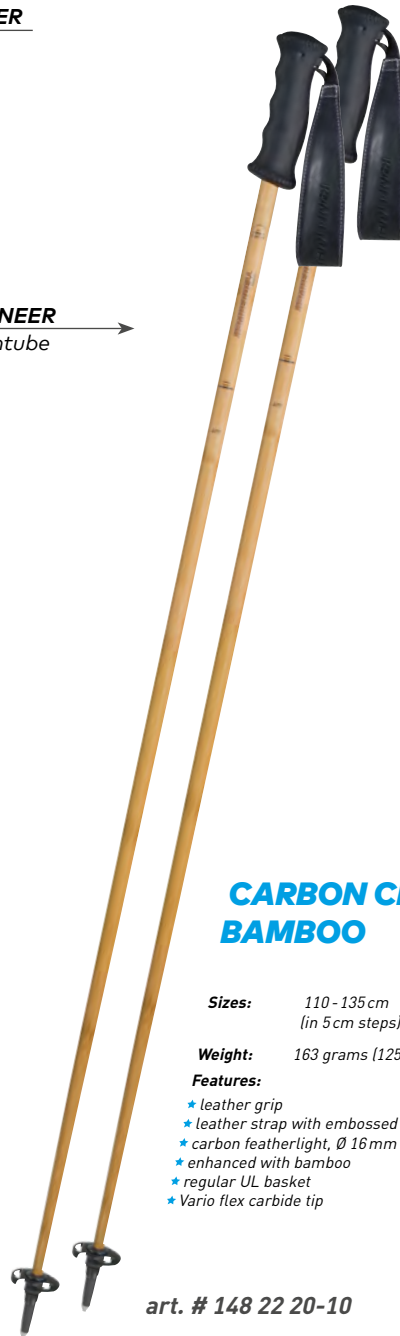

## CARBON CLOUD BAMBOO

**Sizes:** 110 - 135 cm  
(in 5 cm steps)

**Weight:** 163 grams (125 cm)

**Features:**

- \* leather grip
- \* leather strap with embossed logo
- \* carbon featherlight, Ø 16 mm
- \* enhanced with bamboo
- \* regular UL basket
- \* Vario flex carbide tip

art. # 148 22 20-10





## CARBON CLOUD DARK KNIGHT

**Sizes:** 110 - 135 cm  
(in 5 cm steps)

**Weight:** 134 grams (125 cm)

**Features:**

- \* Foam Pistol grip
- \* Air Padded Strap
- \* carbon, Ø 16 mm cloud
- \* Mini UL bakset
- \* Vario flex carbide tip

art. # 148 23 42-10



## CARBON CLOUD WHITE KNIGHT

**Sizes:** 110 - 135 cm  
(in 5 cm steps)

**Weight:** 134 grams (125 cm)

**Features:**

- \* Foam Pistol grip
- \* Air Padded Strap
- \* carbon, Ø 16 mm cloud
- \* Mini UL bakset
- \* Vario flex carbide tip

art. # 148 23 43-55

# ALPINE CLOUD

**OUR MOST LIGHTWEIGHT POLE**



# ALPINE BOOSTER





### BOOSTER SPEED CARBON SERIES

**Sizes:** 110 - 135 cm  
(in 5 cm steps)

**Weight:** 194 grams (125 cm)

**Features:**

- \* 2K Pistol grip
- \* comfort strap
- \* Carbon, Ø 13 mm
- \* mini UL basket
- \* flex steel tip

- art. # 146 23 43-10 black-red
- art. # 146 23 44-10 black-yellow
- art. # 146 23 47-09 white-silver
- art. # 146 23 46-10 black-grey



### BOOSTER SPEED ALUMINUM SERIES

**Sizes:** 110 - 135 cm  
(in 5 cm steps)

**Weight:** 199 grams (125 cm)

**Features:**

- \* 2K Pistol grip
- \* comfort strap
- \* Aluminum, Ø 16 mm
- \* mini UL basket
- \* flex steel tip

- art. # 138 23 88-02 black-yellow
- art. # 138 23 95-09 white-silver
- art. # 138 23 90-02 black-red
- art. # 138 23 92-03 red-black
- art. # 138 23 96-02 black-grey

# ALPINE BLAZER





### BLAZER BLACK/WHITE

**Sizes:** 110 - 135 cm  
(in 5 cm steps)

**Weight:** 230 grams (125 cm)

**Features:**

- \* race grip PU soft
- \* system strap
- \* Aluminum 5086, Ø 18 mm
- \* mini UL basket
- \* steel tip

■ art. # 132 22 45-02 black  
□ art. # 132 22 46-01 white



### BLAZER

**Sizes:** 110 - 135 cm  
(in 5 cm steps)

**Weight:** 230 grams (125 cm)

**Features:**

- \* racegrip PE
- \* standard strap
- \* Aluminum 5086, Ø 18 mm
- \* mini UL basket
- \* steel tip

art. # 132 11 06-10



FUNNEL  
TO FILL ←

### ALPINE SCHNAPSPOLE

**Sizes:** 110 - 135 cm  
(in 5 cm steps)

**Weight:** 327 grams (125 cm)

**Features:**

- \* inner tube for Schnaps funnel included
- \* volume: approx. 0,2l /pole
- \* PE-grip with inner tube
- \* standard strap
- \* Aluminum 7075, Ø 19 mm
- \* mini UL basket
- \* steel tip

art. # 144 93 03-02

**ALPINE  
JUNIOR**







**3** YEAR SERVICE  
NO QUESTIONS ASKED

### SABRE SMASH

**Sizes:** adjustable from 80 - 105 cm

**Features:**

- \* Sabre grip junior
- \* Twist Lock system
- \* 2-sections:  
aluminum 7075, Ø 16/14 mm
- \* racing basket vario
- \* steel tip

art. # 164 32 04-48

**TWISTLOCK MECHANISM**  
Due to the easy mechanism the length can be adjusted from 80 - 105 cm individually to your child



**3** YEAR SERVICE  
NO QUESTIONS ASKED

### SMASH SERIES

**Sizes:** adjustable from 80 - 105 cm

**Features:**

- \* PU grip junior
- \* standard strap
- \* Twist Lock system
- \* 2-sections:  
aluminum 7075, Ø 16/14 mm
- \* racing basket vario
- \* steel tip

■ art. # 164 32 01-48 green

■ art. # 164 32 02-03 red

■ art. # 164 32 03-14 pink

# ALPINE CHAMP



## CHAMP GREEN JUNIOR SUPER-G HENRIK

**Sizes:** 70 - 105 cm  
(in 5 cm steps)

**Features:**

- ★ race grip junior
- ★ standard strap
- ★ aluminum 5086, Ø16 mm, bent
- ★ mini race basket
- ★ steel tip

art. # 221 22 05-02



## CHAMP PINK JUNIOR SUPER-G ALICE

**Sizes:** 70 - 105 cm  
(in 5 cm steps)

**Features:**

- ★ race grip junior
- ★ standard strap
- ★ aluminum 5086, Ø16 mm, bent
- ★ mini race basket
- ★ steel tip

art. # 221 22 06-02



### CHAMP GREEN JUNIOR HENRIK

**Sizes:** 70 - 105 cm  
(in 5 cm steps)

**Features:**

- \* race grip junior
- \* standard strap
- \* aluminum 5086, Ø 14 mm
- \* mini race basket
- \* steel tip

art. # 211 22 12-02



### CHAMP PINK JUNIOR ALICE

**Sizes:** 70 - 105 cm  
(in 5 cm steps)

**Features:**

- \* race grip junior
- \* standard strap
- \* aluminum 5086, Ø 14 mm
- \* mini race basket
- \* steel tip

art. # 211 22 13-02



### CHAMP RED JUNIOR ALICE

**Sizes:** 70 - 105 cm  
(in 5 cm steps)

**Features:**

- \* race grip junior
- \* standard strap
- \* aluminum 5086, Ø 14 mm
- \* mini race basket
- \* steel tip

art. # 211 22 14-02

# ALPINE JUNIOR





**SABRE GRIP**  
safety grip  
without strap



### GREEN RUSH

**Sizes:** 70 - 105 cm  
(in 5 cm steps)

**Features:**

- \* Sabre grip junior
- \* aluminum 5083, Ø 14 mm
- \* racing basket
- \* steel tip

art. # 211 22 07-48



### BRIGHT YELLOW

**Sizes:** 70 - 105 cm  
(in 5 cm steps)

**Features:**

- \* race grip junior
- \* junior strap
- \* aluminum 5083, Ø 14 mm
- \* racing basket
- \* steel tip

art. # 211 33 05-15



### REALLY PINK

**Sizes:** 70 - 105 cm  
(in 5 cm steps)

**Features:**

- \* race grip junior
- \* junior strap
- \* aluminum 5083, Ø 14 mm
- \* racing basket
- \* steel tip

art. # 211 22 08-28



### EVERGREEN

**Sizes:** 70 - 105 cm  
(in 5 cm steps)

**Features:**

- \* race grip junior
- \* junior strap
- \* aluminum 5083, Ø 14 mm
- \* racing basket
- \* steel tip

art. # 211 22 09-48

**ALPINE  
JUNIOR**





### BLUE BOOST

**Sizes:** 70 - 105 cm  
(in 5 cm steps)

**Features:**

- \* race grip junior
- \* junior strap
- \* aluminum 5083, Ø 14 mm
- \* racing basket
- \* steel tip

art. # 211 22 10-04



### RED PEAK

**Sizes:** 70 - 105 cm  
(in 5 cm steps)

**Features:**

- \* race grip junior
- \* junior strap
- \* aluminum 5083, Ø 14 mm
- \* racing basket
- \* steel tip

art. # 211 22 11-03



### CHALLENGER

**Sizes:** 70 - 105 cm  
(in 5 cm steps)

**Features:**

- \* junior Jet grip
- \* junior strap
- \* aluminum 5083, Ø 14 mm
- \* racing basket
- \* steel tip

art. # 211 11 03-10

**THE SET FOR BEGINNERS**  
perfect for those first attempts at skiing



### KIDS SKI-SET

**Sizes:** 60 cm  
70 cm

- \* skiset for beginners
- \* available in two lengths

■ art. # 201-115 Spike Boys

■ art. # 201-116 Lucy Girls

**RENTAL  
ALPIN**



# **RENTAL ALPIN**

**HIGH QUALITY CARBON POLES WITH A  
2-YEAR BREAKAGE GUARANTEE**

*Particularly light and stable alpine pole, it will give your customer  
a lot of pleasure.*





➔ **THE MOST COMPREHENSIVE RENTAL PROGRAM KOMPERDELL HAS EVER PRESENTED**  
 We offer you the right poles, protectors and snowshoes, simply the optimal rental product.

➔ **INDIVIDUAL LOGO-PRINTS**  
 We can personalize and print your logos on the poles, protectors and snowshoes even when only small quantities are ordered.

➔ **OUR SERVICE AND WARRANTY-ADJUSTMENTS ARE THE BEST**  
 As we are convinced of the quality of our products, we grant you a **2-season breakage warranty** on all carbon poles.

**OPTIONAL GRIPS:**



**EVA FOAM GRIP**

art. # 847-02



**LIGHTNING DUPLO GRIP**

art. # 8047-110



**RENTAL CARBON ADULT / JUNIOR**

**Sizes:** Adult: 110 - 135 cm (in 5 cm Steps)  
 Junior: 80 - 105 cm (in 5 cm Steps)

**Features:**

- ★ PU grip with Komperdell logo / KW JET PE Grip
- ★ system strap XL
- ★ carbon, Ø 13 mm
- ★ mini race basket
- ★ flex steel tip

art. # 146 23 10-10 adult  
 art. # 146 22 10-10 junior



**RENTAL VARIO ADULT / JUNIOR**

**Sizes:** Adult: 105 - 135 cm  
 Junior: 80 - 105 cm

**Features:**

- ★ PU Grip with Komperdell Logo / KW Jet PE grip
- ★ system strap XL
- ★ Alu 7075-T6 Ø 18/16 mm / Alu 7075-T6, Ø 16/14 mm
- ★ mini race basket
- ★ flex steel tip

art. # 184 22 08-02 adult  
 art. # 164 22 02-02 junior

**COLOUR CODE VIA POLE TIPS**  
 a different colour per length (sizes in cm)

|     |     |     |     |     |
|-----|-----|-----|-----|-----|
| 70  | 75  | 80  | 85  | 90  |
| 95  | 100 | 105 | 110 | 115 |
| 120 | 125 | 130 | 135 |     |



**RENTAL SOFT CLEAR THERMO ADULT / JUNIOR**

**Sizes:** Adult: 110 - 135 cm (in 5 cm steps)  
 Junior: 70 - 105 cm (in 5 cm steps)

**Eigenschaften:**

- ★ PU Softgriff / KW Jet PE Griff
- ★ system strap XL / Junior strap
- ★ Alu 7075-T6, Ø 19 mm / Alu 5083, Ø 16 mm
- ★ mini race basket
- ★ flex steel tip

art. # 144 23 09-10 adult  
 art. # 221 23 09-10 junior

**RENTAL  
TOURING**



# **RENTAL TOURING**

*HIGH QUALITY POLES WITH A 2-YEARS BREAKAGE GUARANTEE*

*With telescopic poles, you always have the suitable length for your customers in your outlet – for touring and snowshoeing.*





## RENTAL TOUR CARBON

**Sizes:** adjustable from 105 - 140cm (in 5cm steps)

**Weight:** 190 grams

**Features:**

- ★ Contour Foam grip
- ★ System strap
- ★ 2-sections:  
Upper part: Aluminum, Ø 16 mm  
Lower part: Carbon, Ø 14mm
- ★ Large UL vario basket
- ★ Flex Tungsten/Carbide tip

art. # 184 23 88-10



**POWERLOCK 3.0**  
highly rigid, anodized  
aluminum for maximum  
holding power!

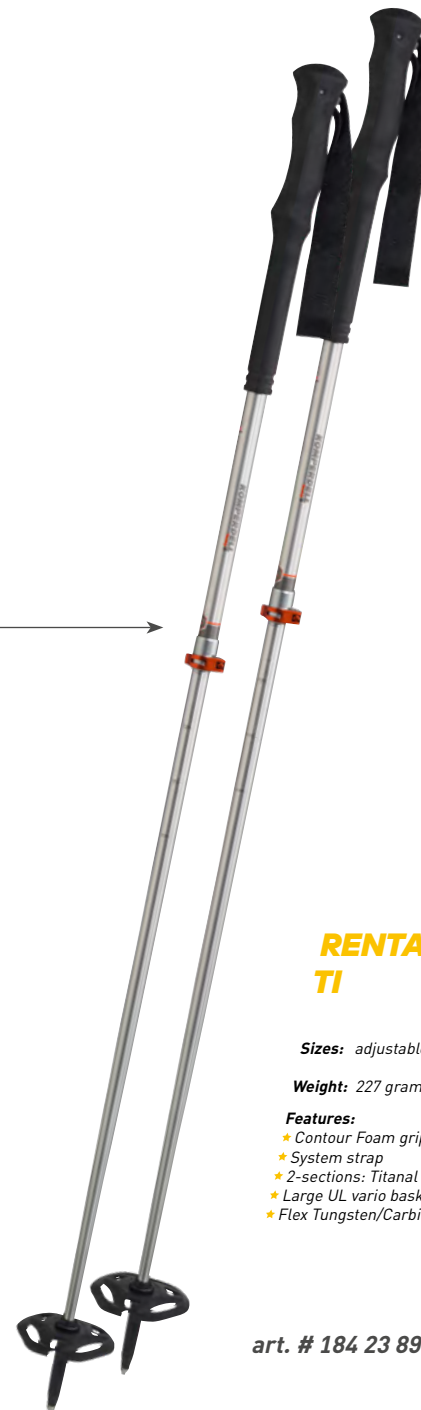

## RENTAL TOUR TI

**Sizes:** adjustable from 105 - 140cm

**Weight:** 227 grams

**Features:**

- ★ Contour Foam grip
- ★ System strap
- ★ 2-sections: Titanal 7075-T6, Ø 18/16 mm
- ★ Large UL vario basket
- ★ Flex Tungsten/Carbide tip

art. # 184 23 89-10

**RENTAL  
NORDIC**





## NORDIC RENTAL VARIO

**Sizes:** adjustable from 110 - 150 cm

**Weight:** 229 grams

**Features:**

- \* Nordic Foam grip
- \* padded Nordic strap
- \* 2-sections: Titanal 7075-T6, Ø 18/16 mm
- \* Powerlock 3.0 mechanism
- \* BC Nordic basket
- \* Nordic steel tip

art. # 184 23 90-02



## NORDIC CARBON RENT

**Sizes:** 120 - 180 cm (in 5 cm steps)

**Weight:** 170 grams (155 cm)

**Features:**

- \* Nordic 2K rubber grip
- \* Click-In race strap
- \* Carbon, Ø 16mm
- \* weight 100g/150cm/bending 17.5mm
- \* Nordic trail UL basket
- \* Carbid tip

art. # 520 23 17-10



# RENTAL SNOWSHOES



## RENTAL SNOWSHOES

### LIGHT AND DURABLE

*Due to our experience we developed snowshoe that are perfectly suitable for rental. The high performance aluminum frame and the Hypalon Decking make the snowshoe durable and lightweight. Additionally you will get maximum comfort with our Easy-Step-In Binding.*





T30 red

## PEAKMASTER SNOWSHOE 30

**Size:** T30 - up to 120 kg (baggage included)

**Weight:** T30 - 967 grams/piece

**Features:**

- ★ Anodized High-Performance Aluminum Frame
- ★ Durable Hypalon decking
- ★ Steel Front claw and middle claw for traction in different conditions
- ★ Heel Lift
- ★ Easy Step-In Binding in 3 sizes available

■ art. # 6576-10 T30 red



T25 blue

## PEAKMASTER SNOWSHOE 25

**Size:** T25 - up to 100 kg (baggage included)

**Weight:** T25 - 883 grams/piece

**Features:**

- ★ Anodized High-Performance Aluminum Frame
- ★ Durable Hypalon decking
- ★ Steel Front claw and middle claw for traction in different conditions
- ★ Heel Lift
- ★ Easy Step-In Binding in 3 sizes available

■ art. # 6577-10 T22 blue



T22 ribes

## PEAKMASTER SNOWSHOE 22

**Size:** T22 - up to 80 kg (baggage included)

**Weight:** T22 - 833 grams/piece

**Features:**

- ★ Anodized High-Performance Aluminum Frame
- ★ Durable Hypalon decking
- ★ Steel Front claw and middle claw for traction in different conditions
- ★ Heel Lift
- ★ Easy Step-In Binding in 3 sizes available

■ art. # 6578-10 T22 ribes

# RENTAL PROTECTION



*Pro Vest*

**KOMPERDELL**  
Rental Protection





MEETS  
FIS REGULATIONS



EAN-CODES &  
INDIVIDUAL LOGO  
PRINT AVAILABLE



## FLEX PACK ADULT/JUNIOR

**Sizes:** Adult: XXS - XL  
Junior: 128 - 140 - 152

**Features:**

- ★ multilayer Cross Flex back-protector made of adaptive dual-density foam, EN-approved 1621-2
- ★ conforms to FIS regulations
- ★ anatomic shaped back part
- ★ new preshaped strap system for best fit - shoulder it like a backpack
- ★ protector insert visible - part of the design concept
- ★ ultimate freedom of movement
- ★ slim kidney belt for perfect fit, adjustable with velcro and plush

art. # 6362-213 Adult

art. # 6363-213 Junior

# NORDIC XC CX-80



## CX-80

THE LIGHTEST AND STIFFEST POLES  
FOR MAXIMUM SPEED

*By far the best shafts worldwide –  
unsurpassed in the ratio of weight to stiffness.*



# Rembrandtin

## SIZE CHART FOR SKATING & RACING

| Person | Stick  |
|--------|--------|
| 140 cm | 120 cm |
| 145 cm | 125 cm |
| 150 cm | 130 cm |
| 155 cm | 135 cm |
| 160 cm | 140 cm |
| 165 cm | 145 cm |
| 170 cm | 150 cm |
| 175 cm | 155 cm |
| 180 cm | 160 cm |
| 185 cm | 165 cm |
| 190 cm | 170 cm |
| 195 cm | 175 cm |
| 200 cm | 180 cm |

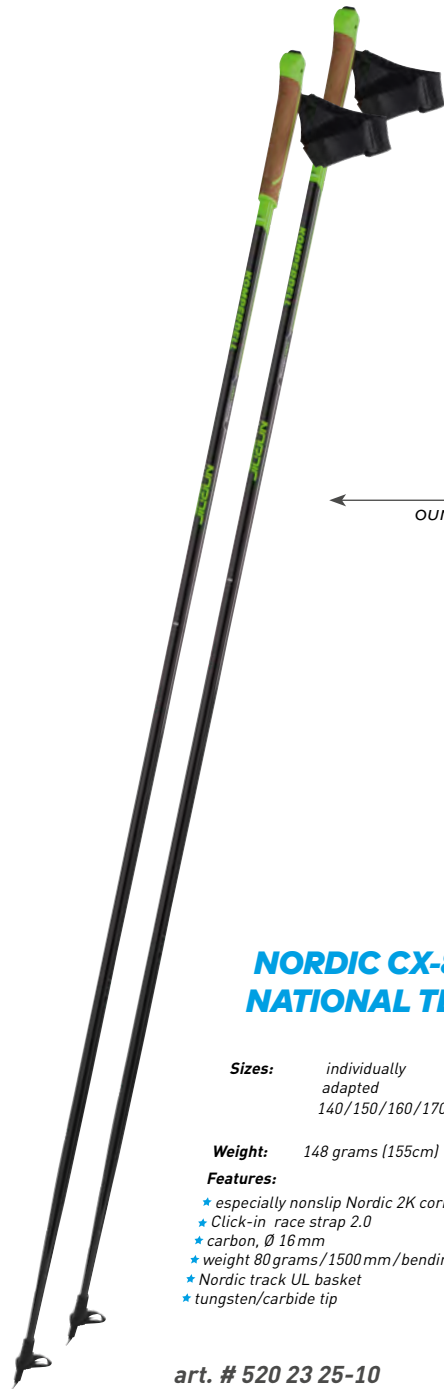

### NORDIC CX-80 NATIONAL TEAM

**Sizes:** individually adapted  
140/150/160/170/180 cm

**Weight:** 148 grams (155cm)

**Features:**

- \* especially nonslip Nordic 2K cork grip
- \* Click-in race strap 2.0
- \* carbon, Ø 16 mm
- \* weight 80 grams/1500 mm/bending 15 mm
- \* Nordic track UL basket
- \* tungsten/carbide tip

art. # 520 23 25-10

← our lightest and stiffest carbon shafts →  
**CX-80**

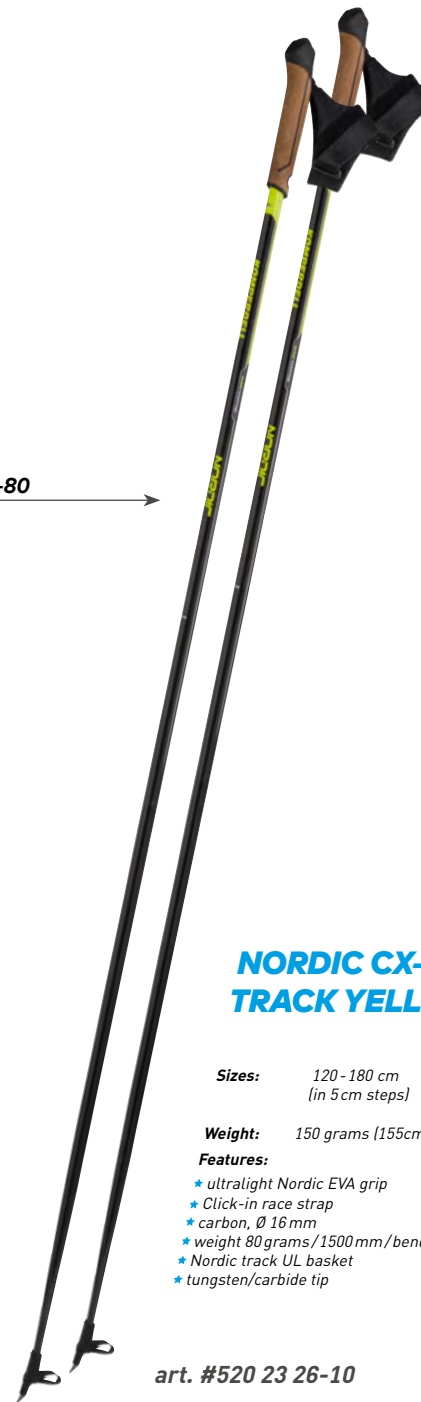

### NORDIC CX-80 TRACK YELLOW

**Sizes:** 120 - 180 cm  
(in 5 cm steps)

**Weight:** 150 grams (155cm)

**Features:**

- \* ultralight Nordic EVA grip
- \* Click-in race strap
- \* carbon, Ø 16 mm
- \* weight 80 grams/1500 mm/bending 15 mm
- \* Nordic track UL basket
- \* tungsten/carbide tip

art. #520 23 26-10



# NORDIC XC CX-100



## CX-100

PERFECT IN TERMS OF WEIGHT,  
STIFFNESS AND PRICE-PERFORMANCE

*With the new click-in strap, handling is easy and it fits, ergonomically perfect.*



**SIZE CHART FOR SKATING & RACING**

| Person | Stick  |
|--------|--------|
| 140 cm | 120 cm |
| 145 cm | 125 cm |
| 150 cm | 130 cm |
| 155 cm | 135 cm |
| 160 cm | 140 cm |
| 165 cm | 145 cm |
| 170 cm | 150 cm |
| 175 cm | 155 cm |
| 180 cm | 160 cm |
| 185 cm | 165 cm |
| 190 cm | 170 cm |
| 195 cm | 175 cm |
| 200 cm | 180 cm |

**NATURAL CORK GRIP**

sweat absorbing and light

**EXTRA STIFF CX-100 SHAFT**

improved transmission of force

**SIZE CHART FOR SKATING & RACING**

| Person | Stick  |
|--------|--------|
| 140 cm | 110 cm |
| 145 cm | 115 cm |
| 150 cm | 120 cm |
| 155 cm | 125 cm |
| 160 cm | 130 cm |
| 165 cm | 135 cm |
| 170 cm | 140 cm |
| 175 cm | 145 cm |
| 180 cm | 150 cm |
| 185 cm | 155 cm |
| 190 cm | 160 cm |
| 195 cm | 165 cm |
| 200 cm | 170 cm |

**NORDIC CX-100 CORK**

**Sizes:** 120 - 180 cm  
(in 5 cm steps)

**Weight:** 168 grams (155cm)

**Features:**

- \* padded Nordic 2K Cork Grip
- \* Click-in strap 2.0
- \* carbon, Ø 16mm
- \* weight 100g/150cm/bending 17.5mm
- \* Nordic trail UL basket
- \* tungsten/carbide tip

- art. # 520 23 27-10 yellow
- art. # 520 23 28-10 red
- art. # 520 23 29-10 blue
- art. # 520 23 30-10 pink

**NORDIC CX-100 SPORT**

**Sizes:** 120 - 180 cm  
(in 5 cm steps)

**weight:** 170 grams (155cm)

**Features:**

- \* especially nonslip Nordic 2K rubber grip
- \* Click-in strap 2.0
- \* carbon, Ø 16mm
- \* weight 100g/1500mm/bending 17.5 mm
- \* Nordic trail UL basket
- \* tungsten/carbide tip

- art. # 520 23 17-10 yellow
- art. # 520 23 18-10 red
- art. # 520 23 19-10 blue
- art. # 520 23 20-10 pink

# NORDIC XC ADVENTURE



**3 YEAR SERVICE**  
NO QUESTIONS ASKED

**SIZE CHART FOR CLASSIC & TOURING**

|  |  |
|---|---|
| 140 cm  | 110 cm  |
| 145 cm  | 115 cm  |
| 150 cm  | 120 cm  |
| 155 cm  | 125 cm  |
| 160 cm  | 130 cm  |
| 165 cm  | 135 cm  |
| 170 cm  | 140 cm  |
| 175 cm  | 145 cm  |
| 180 cm  | 150 cm  |
| 185 cm  | 155 cm  |
| 190 cm  | 160 cm  |
| 195 cm  | 165 cm  |
| 200 cm  | 170 cm  |



**NORDIC ADVENTURE VARIO**

**Sizes:** adjustable from 110 - 155 cm

**Features:**

- \* Nordic foam grip
- \* padded Nordic strap
- \* 2-sections: aluminum 7075, Ø 18/16 mm
- \* Powerlock 3.0 mechanism
- \* BC Nordic basket
- \* Nordic steel tip

art. # 184 23 64-02

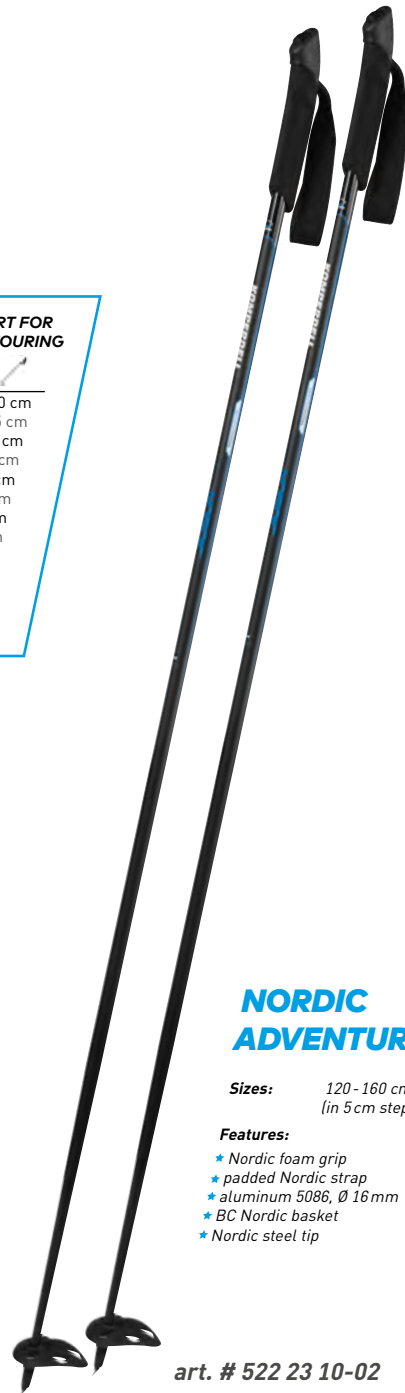

**NORDIC ADVENTURE**

**Sizes:** 120 - 160 cm (in 5 cm steps)

**Features:**

- \* Nordic foam grip
- \* padded Nordic strap
- \* aluminum 5086, Ø 16 mm
- \* BC Nordic basket
- \* Nordic steel tip

art. # 522 23 10-02



**NORDIC PRIME**

**Sizes:** 120 - 160 cm (in 5 cm Schritten)

**Features:**

- \* XC Kork grip
- \* padded Nordic strap
- \* Aluminum 5086, Ø 16 mm
- \* XC Teller
- \* Nordic steel tip

art. # 522 23 11-12



**NORDIC CLASSIC**

**Sizes:** Adult: 120 - 160 cm  
Junior: 90 - 115 cm (in 5 cm steps)

**Features:**

- \* Nordic XC grip
- \* Nordic classic strap
- \* aluminum 5083, Ø 16 mm
- \* XC standard basket
- \* Nordic steel tip

art. # 522 11 02-10 Adult  
art. # 222 11 21-10 Junior

# FREERIDE FATSO

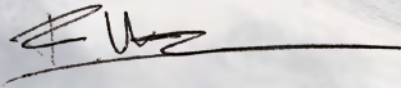

**FELIX WIEMERS**  
Deutschlands bester Freerider



# FATSO

THE POLE FOR THE REAL FREE RIDERS

Best grip thanks to non-slip coating. Particularly wide, extra light and long grip-zone for best comfort and with an easy to adjust powder strap.

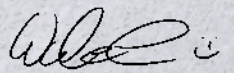

**EVA WALKNER**  
2-times overall winner  
of Freeride World Tour



**POWERLOCK 3.0**  
highly rigid, anodized  
aluminum for maximum  
holding power!



**3 YEAR SERVICE**  
NO QUESTIONS ASKED

107 cm

**ICE-FLEX BASKET**  
adapts to the slope –  
up to 28°

### FATSO CARBON TEAM VARIO

**Sizes:** packed size: 107 cm  
adjustable from 110 - 140 cm

**Weight:** 257 Gramm

**Features:**

- \* Fatso 430 grip
- \* Powder Padded strap
- \* 2-sections:  
upper part: aluminum 7075-T6, Ø16 mm  
lower part: carbon, Ø14 mm
- \* Powerlock 3.0 mechanism
- \* XL ice-flex basket
- \* ice-flex tungsten carbide-tip

art. # 175 20 05-10

**3 YEAR SERVICE**  
NO QUESTIONS ASKED

107 cm

### FATSO VARIO TI

**Sizes:** packed size: 107 cm  
adjustable from 110 - 140 cm

**Weight:** 268 Gramm

**Features:**

- \* Fatso 430 grip
- \* Powder Padded strap
- \* 2-sections:  
aluminum 7075-T6, Ø18/16 mm
- \* Powerlock 3.0 mechanism
- \* XL ice-flex basket
- \* ice-flex tungsten carbide tip

art. # 184 23 97-20

**3 YEAR SERVICE**  
NO QUESTIONS ASKED

107 cm

### FATSO VARIO TI

**Sizes:** packed size: 107 cm  
adjustable from 110 - 140 cm

**Weight:** 268 Gramm

**Features:**

- \* Fatso 430 grip
- \* Powder Padded strap
- \* 2-sections:  
aluminum 7075-T6, Ø18/16 mm
- \* Powerlock 3.0 mechanism
- \* XL ice-flex basket
- \* ice-flex tungsten carbide tip

art. # 184 23 96-66



# D'SCENT

FREESKIING - TOURING - BACKCOUNTRY

*A brandnew generation of poles. Designed for skiers who ski a lot off piste and in the backcountry. They have all the features needed for a safe descent but also for an effortless ascent when skiing in the backcountry.*





## **CLICK-IN STRAP**

*Designed for additional safety when skiing in the backcountry. On ascents the ergonomically shaped straps are super comfortable to use but can be taken off with a simple push of the button for descents.*



## **ICE FLEX SYSTEM**

*Our articulating basket is designed for skiing steeper or harder slopes with large flotation baskets. The ability to adjust to the slope of the terrain makes it so much easier to get a good and safe grip on the slope when skiing with large flotation baskets.*



## **BACKCOUNTRY GRIP**

*All our poles feature an extended gripzone. Great to choke up on the pole when climbing steeper slopes. The griphead is designed to operate the heel lifts on almost all touring bindings on the market.*

# TOURING D'SCENT





### D'SCENT CARBON VARIO

**Sizes:** packed size: 97 cm  
adjustable from 110 - 140 cm

**Features:**

- \* X-Touring Foam 280 Camo
- \* extended grip zone
- \* Click-In 2.1 Ergo strap with strap change system
- \* 2-sections:  
upper part: aluminum 7075-T6, Ø 16mm  
lower section: carbon, Ø 14mm
- \* Powerlock 3.0 mechanism
- \* large UL ice-flex basket
- \* ice-flex tungsten/carbide tip

art. # 175 23 72-10



**POWERLOCK 3.0**  
highly rigid, anodized  
aluminum for maximum  
holding power!



### D'SCENT TI VARIO

**Sizes:** packed size: 97 cm  
adjustable from 110 - 140 cm

**Features:**

- \* Click-In grip 2K click-in grip
- \* extended Thermo grip zone
- \* Click-In 2.1 Ergo strap with strap change system
- \* 2-sections:  
aluminum 7075-T6, Ø 18/16mm
- \* Powerlock 3.0 mechanism
- \* large UL ice-flex basket
- \* ice-flex tungsten/carbide tip

art. # 184 23 98-10

# TOURING D'SCENT



## D'SCENT CARBON

**Sizes:** 105 - 135 cm  
(in 5 cm steps)

**Features:**

- ★ X-Tour Click-In Foam Camo grip
- ★ Click-In 2.1 Ergo strap with strap change system
- ★ carbon, Ø 16mm
- ★ regular UL ice-flex basket
- ★ ice-flex tungsten/carbide tip

art. # 148 23 50-10



## D'SCENT TI FREERIDE

**Sizes:** 105 - 135 cm  
(in 5 cm steps)

**Features:**

- ★ 2K grip
- ★ extended Thermo grip zone
- ★ Click-In 2.1 Ergo strap with strap change system
- ★ aluminum 7075-T6, Ø 18mm
- ★ large UL ice-flex basket
- ★ ice-flex tungsten/carbide tip

art. # 134 23 09-10





## D'SCENT TI

**Sizes:** 105 - 135 cm  
(in 5 cm steps)

**Features:**

- ★ 2K grip
- ★ Click-In 2.1 Ergo strap with strap change system
- ★ aluminum 7075-T6, Ø 18mm
- ★ regular UL ice-flex basket
- ★ ice-flex tungsten/carbide tip

- art. # 134 23 06-12 steel grey
- art. # 134 23 10-10 sand
- art. # 134 23 07-01 white
- art. # 134 23 08-20 mint

**TOURING  
ULTRALIGHT**



# **C2 ULTRALIGHT**

**THE LIGHTEST POLE – 193 GRAM ONLY**

*We are the expert for carbon poles. Thanks to years of experience and extensive know-how, we manufacture the best for the best – more fun on every ski tour.*





**3 YEAR SERVICE**  
ON ALL SKIS AND BINDINGS

**3 YEAR SERVICE**  
ON ALL SKIS AND BINDINGS

**POWERLOCK 3.0**  
 highly rigid, anodized  
 aluminum for maximum  
 holding power!



98 cm

**ICE FLEX BASKET**  
 adapts to the slope -  
 up to 28°

### CARBON C2 ULTRALIGHT

**Sizes:** packed size: 98 cm  
 adjustable from 110 - 140 cm

**Features:**

- \* Touring Foam Camo 280 grip
- \* extended grip zone
- \* Comfort Padded strap
- \* 2-sections:  
 upper part: carbon Cloud, Ø 18mm  
 lower part: carbon Composite, Ø 16mm
- \* Powerlock 3.0 mechanism
- \* large UL ice-flex basket
- \* ice-flex tungsten/carbide tip

- art. # 175 23 75-10 orange
- art. # 175 23 76-10 berry

98 cm

### CARBON C7 ASCENT

**Sizes:** packed size: 98 cm  
 adjustable from 110 - 140 cm

**Features:**

- \* Touring Fatso grip
- \* extended grip zone
- \* Comfort Padded strap
- \* 2-sections:  
 carbon, Ø 18/16mm
- \* Powerlock 3.0 mechanism
- \* large UL ice-flex basket
- \* ice-flex tungsten/carbide tip

- art. # 175 23 77-10 green
- art. # 175 23 78-10 blue
- art. # 175 23 79-10 berry

**TOURING  
TITANAL.HF**



# **CONTOUR TITANAL**

**THE POLE FOR ENTHUSIASTIC MOUNTAINEERS**

*The ultra-light and almost indestructible pioneer among the touring poles has been in our collection for 20 years. Consistently improved, it is still the pole that true passionate mountaineers rely on today.*





**3 YEAR SERVICE**  
NO QUESTIONS ASKED

100 cm

### FREE TOURING JUNIOR

**Sizes:** packed size: 100 cm  
adjustable from 105 - 120 cm

**Features:**

- \* Touring Foam Camo 280 grip
- \* extended grip zone
- \* Comfort Padded strap
- \* 2-sections:  
aluminum 7075-T6, Ø 18/16mm
- \* Powerlock 3.0 mechanism
- \* regular UL Vario basket
- \* vario tungsten/carbide flex tip

art. # 164 23 15-10



**3 YEAR SERVICE**  
NO QUESTIONS ASKED

100 cm

### FREE TOURING TI

**Sizes:** packed size: 100 cm  
adjustable from 105 - 135 cm

**Features:**

- \* Touring Foam 280 grip
- \* extended grip zone
- \* Comfort Padded strap
- \* 2-sections:  
upper part: aluminum 7075-T6, Ø 18mm  
lower part: Titanal Ti-7 Ø 16mm
- \* Powerlock 3.0 mechanism
- \* large UL ice-flex basket
- \* ice-flex tungsten/carbide tip

art. # 184 23 81-02



**3 YEAR SERVICE**  
NO QUESTIONS ASKED

85 cm

### CONTOUR TITANAL II FOAM

**Sizes:** packed size: 85 cm  
adjustable from 105 - 140 cm

**Features:**

- \* Touring Foam 450 grip
- \* extra long grip zone
- \* Comfort Padded strap
- \* 2-sections:  
Titanal.HF, Ø 16/14mm
- \* Powerlock 3.0 mechanism
- \* large UL Vario basket
- \* vario tungsten/carbide flex tip

art. # 188 23 05-10



**3 YEAR SERVICE**  
NO QUESTIONS ASKED

80 cm

### CONTOUR TITANAL II FOAM COMPACT

**Sizes:** packed size: 80 cm  
adjustable from 105 - 130 cm

**Features:**

- \* Touring Foam 450 grip
- \* extra long grip zone
- \* Comfort Padded strap
- \* 2-sections:  
Titanal.HF, Ø 16/14mm
- \* Powerlock 3.0 mechanism
- \* large UL Vario basket
- \* vario tungsten/carbide flex tip

art. # 188 23 06-10

# TOURING ALUMINUM





### THERMO ASCENT TI 3

**Sizes:** packed size: 72 cm  
adjustable from 115 - 150 cm

**Features:**

- \* EVA foam grip
- \* Thermogrip foam
- \* system strap XL
- \* 3-sections:  
aluminum 7075-T6, Ø 18/16/14 mm
- \* Powerlock 3.0 mechanism
- \* vario winter basket
- \* vario tungsten/carbide flex tip

art. # 174 23 54-10



### FREE TOURING THERMO ADVENTURE

**Sizes:** packed size: 102 cm  
adjustable from 115 - 150 cm

**Features:**

- \* EVA foam grip
- \* extended Thermo grip zone
- \* system strap XL
- \* 2-sections:  
upper part: aluminum 7075-T6, Ø 18 mm  
lower part: Titanal Ti 7, Ø 16 mm
- \* Powerlock 3.0 mechanism
- \* LARGE UL Vario basket
- \* vario tungsten/carbide flex tip

art. # 184 23 94-10



### T2 THERMO ADVENTURE

**Sizes:** packed size: 85 cm  
adjustable from 115 - 150 cm

**Features:**

- \* EVA foam grip
- \* extended Thermo grip zone
- \* system strap XL
- \* 2-sections:  
aluminum 7075-T6, Ø 18/16 mm
- \* Powerlock 3.0 mechanism
- \* vario winter basket
- \* vario tungsten/carbide flex tip

art. # 184 23 95-10

# TOURING SPEED CARBON





Trail Click-In 2.1 strap



### SPEED TOUR CARBON VARIO

**Sizes:** adjustable from 110 - 140 cm

**Features:**

- \* Trail Pro Cork 245 grip
- \* Trail Click-In 2.1 strap
- \* 2-sections:  
carbon, Ø 18/16 mm
- \* Nordic Speed basket
- \* ice flex tip

art. # 175 23 65-10



### SPEED TOUR CARBON PRO

**Sizes:** 115- 145 cm (in 5cm steps)

**Weight:** 168 grams (125cm)

**Features:**

- \* Trail Pro Cork 245 grip
- \* Trail Click-In 2.1 strap
- \* CX-100 carbon
- \* Nordic Speed basket
- \* ice flex tungsten/carbide tip

art. # 148 23 44-10



### SPEED TOUR CARBON

**Sizes:** 115- 145 cm (in 5cm steps)

**Weight:** 154 grams (125cm)

**Features:**

- \* EVA Cork Click-In Nordic grip
- \* NW Click-In 2.0 strap
- \* CX-100 carbon
- \* Nordic BC basket
- \* ice flex tip

art. # 148 23 45-10

**TOURING  
SPEED TI**







### SPEED TOUR TI VARIO

**Sizes:** adjustable from 110-140 cm

**Features:**

- ★ Trail Pro Cork 245 grip
- ★ Trail Click-In 2.1 strap
- ★ 2-sections:  
Titanal 7075-T6, Ø 18/16mm
- ★ Nordic Speed basket
- ★ ice flex tip

art. # 184 23 93-02

← POWDER PADDED STRAP  
sold separately →



### SPEED TOUR TI PRO

**Sizes:** 115-145 cm (in 5cm steps)

**Weight:** 213 grams (125cm)

**Features:**

- ★ Trail Pro Cork 245 grip
- ★ Trail Click-In 2.1 strap
- ★ Titanal 7075-T6
- ★ Nordic Speed basket
- ★ ice flex tip

art. # 524 23 14-02



### SPEED TOUR TI

**Sizes:** 115-145 cm

**Weight:** 193 grams (125cm)

**Features:**

- ★ EVA Cork Click-In Nordic grip
- ★ NW Click-In 2.0 strap
- ★ Titanal 7075-T6
- ★ Nordic BC basket

art. # 524 23 15-02



# TOURING SPLITBOARDING



AWARDED WITH

**OutDoor**  
by ISPO

Outstanding Outdoor

Gold Winner 2019  
an ISPO Award

## CARBON FXP.4 EXPEDITION VARIO

**Sizes:** packed size: 43 cm  
adjustable from 120 - 140 cm

**Gewicht:** 248g

**Features:**

- \* Touring Foam 280 Grip
- \* Verlängerte Griffzone
- \* Comfort Padded Strap
- \* 4-teilig:
- Oberteil: Aluminium 7075-T6, Ø 18mm
- Unterteil: Carbon Composite, Ø 16mm
- \* Powerlock 3.0 Verschluss
- \* FXP Faltmechanismus
- \* Regular UL FXP Teller
- \* Eisflanken Wolfram/Carbid Spitze

art. # 194 23 61-10

## CARBON FXP.4 EXPEDITION VARIO COMPACT

**Sizes:** packed size: 38 cm  
adjustable from 105 - 125 cm

**Weight:** 237g

**Features:**

- \* Touring Foam 280 grip
- \* extended grip zone
- \* Comfort Padded Strap
- \* 4-teilig:
- Oberteil: Aluminium 7075-T6, Ø 18mm
- Unterteil: Carbon Composite, Ø 16mm
- \* Powerlock 3.0 Verschluss
- \* FXP Faltmechanismus
- \* Regular UL FXP Teller
- \* Eisflanken Wolfram/Carbid Spitze

art. # 194 23 62-10



**3 YEAR SERVICE**  
ON ALL PRODUCTS EXCEPT

**AMAG**  
 ROLLING

**3 YEAR SERVICE**  
ON ALL PRODUCTS EXCEPT



65 cm

**CARBON  
 CXP PRO**

**Sizes:** packed size: 65 cm  
 adjustable from 105 - 140 cm

- Features:**
- \* TOURING FOAM 450
  - \* Comfort Padded strap
  - \* 3-sections:
    - upper part: carbon, Ø 18 mm
    - middle section: carbon, Ø 16 mm
    - lower part: Titalan.HF, Ø 14 mm
  - \* Powerlock 3.0 mechanism
  - \* large UL basket
  - \* vario tungsten/carbide flex tip

art. # 175 23 54-10

**POWERLOCK 3.0**  
 highly rigid, anodized  
 aluminum for maximum  
 holding power!



65 cm

**TITANAL  
 EXP PRO**

**Sizes:** packed size: 65 cm  
 adjustable from 105 - 140 cm

- Features:**
- \* TOURING FOAM 450
  - \* Comfort Padded strap
  - \* 3-sections:
    - Titalan.HF, Ø 18/16/14 mm
  - \* Powerlock 3.0 mechanism
  - \* large UL basket
  - \* vario tungsten/carbide flex tip

art. # 174 23 55-10

# TOURING STILETTO



## SUPERIOR BALANCE

Better balance and support in rough terrain, on high steps or when traversing a creek.



## UPHILL BOOST

By having the correct pole-length at all times you achieve better transmission of power.



## RELIEVES STRAIN ON YOUR KNEES

The strain on your knees is reduced because you always have your poles at the correct length.

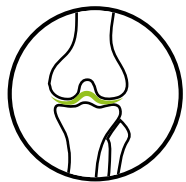

3 YEAR SERVICE  
NO QUESTIONS ASKED

3 YEAR SERVICE  
NO QUESTIONS ASKED

### STILETTO EXPEDITION

**Sizes:** packed size: 62 cm  
130 cm, adjustable from 105 - 130 cm  
140 cm, adjustable from 115 - 140 cm

**Features:**

- \* Stiletto 400 grip
- \* Ergo strap
- \* upper part: Titanal.HF
- \* lower part: carbon
- \* ice-flex basket
- \* ice-flex tungsten/carbide tip

art. # 184 20 02-02



3 YEAR SERVICE  
NO QUESTIONS ASKED

### STILETTO TOUR

**Sizes:** 130 cm, adjustable from 105 - 130 cm  
140 cm, adjustable from 115 - 140 cm

**Features:**

- \* Stiletto 400 grip
- \* Ergo strap
- \* upper part: Titanal.HF
- \* lower part: carbon
- \* ice-flex basket
- \* ice-flex tungsten/carbide tip

art. # 184 20 03-02



**ADJUSTMENT MECHANISM IN THE GRIP – FAST, INTUITIVE & SIMPLE**  
adjust the length anytime, adapt to any situation and slope incline

### AWARDED WITH

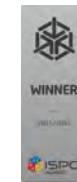



# SNOWSHOES

## THE WORLD'S FIRST CARBON SNOWSHOES

*At Komperdell we are true innovators and to achieve our goal to make a traditional snowshoe 50 % lighter, we had to completely re-think the way a snowshoe is being built. The result is truly amazing - half the weight on your foot makes all the difference!*



## **ONLY 691 GRAMS**

*Both the decking and „Hollow Core AirFrame“ are laminated in one single step in production. The use of ultralight Carbon and this unique production process saves more than 50 % in weight without sacrificing any strength.*



## **TONS OF TRACTION**

*Stainless Steel Rail Claws are laminated directly into the frame and provide tons of traction on ice and hard packed snow.*



## **INSULATED BINDING**

*Our Easy Step In Binding is easy to get in and snuggles up tightly around your shoe. The insulated neoprene toe cover keeps your feet dry and warm, even in deep snow.*



# CARBON SNOWSHOES

THE WORLD'S 1<sup>ST</sup> SNOWSHOES MADE OF CARBON

*50% less weight and incredible traction on ice and hard packed snow.*





**EASY STEP-IN BINDING**  
*guarantees quick entry, necessary tight fit but still comfortable to wear*

**100% CARBON**  
*50% lighter - only 691 grams*

**CARBON AIR FRAME**  
*lightest hollow construction*

**PURE CARBON**  
*completely made in one piece*

**AGGRESSIVE STEEL CLAWS DIRECTLY INTEGRATED INTO THE FRAME**  
*give you tons of traction*

### CARBON AIR FRAME 25

**Sizes:** S, M, L

**Weight:** 691 grams/piece

**Features:**

- \* integral built carbon decking
- \* especially light, hollow-core carbon frame
- \* ice-rail claws for optimal traction
- \* Easy step-in binding with quick-fastener, fitting all sizes and types of boots and offering perfect hold
- \* Toe cover

art. # 6508-10

### COMPOSITE AIR FRAME

**Sizes:** S, M, L

**Weight:** 748 grams/piece

**Features:**

- \* integral built carbon decking
- \* especially light, hollow-core carbon frame
- \* ice-rail claws for optimal traction
- \* Easy step-in binding with quick-fastener, fitting all sizes and types of boots and offering perfect hold

art. # 6368-10

# ALUMINUM SNOWSHOES



## ALUMINUM SNOWSHOES

### LIGHT AND DURABLE

*Due to our experience we developed snowshoe that are perfectly suitable for rental. The high performance aluminum frame and the Hypalon Decking make the snowshoe durable and lightweight. Additionally you will get maximum comfort with our Easy-Step-In Binding.*





T30 red

## PEAKMASTER SNOWSHOE 30

**Size:** T30 - up to 120 kg (baggage included)

**Weight:** T30 - 967 grams/piece

**Features:**

- ★ Anodized High-Performance Aluminum Frame
- ★ Durable Hypalon decking
- ★ Steel Front claw and middle claw for traction in different conditions
- ★ Heel Lift
- ★ Easy Step-In Binding in 3 sizes available

■ art. # 6576-10 T30 red



T25 blue

## PEAKMASTER SNOWSHOE 25

**Size:** T25 - up to 100 kg (baggage included)

**Weight:** T25 - 883 grams/piece

**Features:**

- ★ Anodized High-Performance Aluminum Frame
- ★ Durable Hypalon decking
- ★ Steel Front claw and middle claw for traction in different conditions
- ★ Heel Lift
- ★ Easy Step-In Binding in 3 sizes available

■ art. # 6577-10 T22 blue



T22 ribes

## PEAKMASTER SNOWSHOE 22

**Size:** T22 - up to 80 kg (baggage included)

**Weight:** T22 - 833 grams/piece

**Features:**

- ★ Anodized High-Performance Aluminum Frame
- ★ Durable Hypalon decking
- ★ Steel Front claw and middle claw for traction in different conditions
- ★ Heel Lift
- ★ Easy Step-In Binding in 3 sizes available

■ art. # 6578-10 T22 ribes

# SNOWSHOE ACCESSORIES





## SNOWSHOE TOE COVER

Sizes: S, M, L

**Features:**

- ★ Keeps your feet dry and warm
- ★ Easy attachment to the binding by push button system

art. # 6574-925



## SNOWSHOE GAITER

Sizes: S, L

**Features:**

- ★ Protects from wind, moisture and cold
- ★ Optimal fit, easy length adjustment with cord

art. # 6575-925



## SNOWSHOE SOCKS TITANIUM 0,5 MM

Sizes: 35/36-47/48

**Features:**

- ★ Seamless Bonding System for honest wearing comfort
- ★ Suitable for normal outdoor shoes
- ★ Keeps your feet dry and warm

art. # 6573-925



## TPU SNOWSHOE BINDING

Sizes: S, M, L

**Features:**

- ★ separate Easy-Step-In binding
- ★ Suitable for normal outdoor shoes
- ★ Best wearing comfort

art. # 6572-925



# PROTECTION

*PIONIER – TRENDSETTER – MULTIPLE AWARD WINNER*

*For more than 20 years we have been the leading brand in protection. We are the only brand to not only develop and manufacture the garment but also the protector itself.*





## **SAFETY**

Our protectors have the largest continuous protective zone on the market. Our foam is Multiple Impact Resistant and features the highest impact protective properties on the market. Our protectors have won more than 30 comparative tests and awards over the years.

## **BREATHABILITY & COMFORT**

The design of our protective layers allows for maximum breathability and flexibility of our protectors without sacrificing their protective properties. The protector perfectly contours to your body and our customers rave about the fit and comfort of our vests.

## **MULTILAYER DESIGN**

Our new CrossFlex 6.0 protector is 30 % lighter than prior generations and has a vastly improved flexibility. Compared to prior generations and conventional plate-style protectors our CrossFlex 6.0 protectors offer comfort on a level never heard of before.



# PROTECTION ATHLETIC MEN







### BALLISTIC FLEXFIT MEN

Sizes: XXS - XXL

**Features:**

- \* multilayer Cross Flex back-protector, made of adaptive dual-density foam, EN-approved 1621-2
- \* light and flexible
- \* highest safety values - 360° all around protection
- \* for ultimate mobility
- \* front zipper

art. # 6454-212



### PRO VEST MEN

Sizes: XS - XXL

**Features:**

- \* multilayer Cross Flex back protector made of adaptive dual-density foam, EN-approved 1621-2
- \* side protection of ribs and organs

art. # 6383-206

# PROTECTION ATHLETIC MEN





## AIR VEST MEN BLACK

**Sizes:** XXS-XXL

**Features:**

- \* extra light protector vest with optimized fit
- \* multilayer Cross Flex back protector made of adaptive dual-density foam, EN-approved 1621-2

art. # 6385-206



## AIR VEST MEN WHITE

**Sizes:** XXS-XXL

**Features:**

- \* extra light protector vest with optimized fit
- \* multilayer Cross Flex back protector made of adaptive dual-density foam, EN-approved 1621-2

art. # 6384-01

# PROTECTION ATHLETIC WOMEN





### BALLISTIC FLEXFIT WOMEN

Sizes: XXS-XL

**Features:**

- ★ multilayer Cross Flex back protector made of adaptive dual-density foam, EN-approved 1621-2
- ★ improved ergonometry
- ★ perfect fit & ultimate mobility

art. # 6453-212



ISPO AWARD  
WINNER  
2016/2017



### PRO VEST WOMEN

Sizes: XXS-XL

**Features:**

- ★ multilayer Cross Flex back protector made of adaptive dual-density foam, EN-approved 1621-2
- ★ side protection of ribs and organs

art. # 6387-265

# PROTECTION ATHLETIC WOMEN





### AIR VEST WOMEN WHITE

**Sizes:** XXS - XL

**Features:**

- ★ multilayer Cross Flex back protector made of adaptive dual-density foam, EN-approved 1621-2
- ★ extra light protector vest
- ★ optimized silhouette

art. # 6388-01



### AIR VEST WOMEN BLACK

**Sizes:** XXS - XL

**Features:**

- ★ multilayer Cross Flex back protector made of adaptive dual-density foam, EN-approved 1621-2
- ★ extra light protector vest
- ★ optimized silhouette

art. # 6389-265



### PRO SHORT

**Sizes:** unisex, XS - XL

**Features:**

- ★ comfortable foam material for optimal protection of coccyx, thighs and hips
- ★ sporty look

art. # 6355-212

**PROTECTION  
CASUAL**







**HOODY**  
made of super-soft fleece,  
snugly & warm



**CROSS FLEX PROTECTOR**  
the safest protection -  
EN 1621-2



**KANGAROO  
POCKETS**

## FULL ZIP HOODY SHIRT MEN

**Sizes:** XS - XXL

**Features:**

- \* multilayer Cross FLEX back-protector, made of adaptive dual-density foam, EN-approved 1621-2
- \* made of comfortably fitting fleece 4-way stretch- material
- \* hood with draw-string
- \* integrated kidney-belt, adjustable with velcro fastener
- \* front zip

art. # 6353-207



## FULL ZIP SWEATER MEN

**Sizes:** XS - XXL

**Features:**

- \* multilayer Cross FLEX back-protector, made of adaptive dual-density foam, EN-approved 1621-2
- \* made of comfortably fitting fleece 4-way stretch- material
- \* integrated kidney-belt, adjustable with velcro fastener
- \* front zip

art. # 6354-207

art. # 6354-202

**PROTECTION  
CASUAL**



**4-WAY STRETCH LIGHT SHELL MATERIAL**  
for comfort



**CONCEALED SIDE BREAST POCKETS**  
with zip



**CONCEALED SIDE BREAST POCKETS**  
with zip

**REMOVEABLE HOOD**  
fully customizable with draw-string and rubber cord



**INTEGRATED KIDNEY-BELT**  
adjustable with velcro-fastener



**BEST COLD & WIND PROTECTION**  
due to thermo-insulating, extra light technical materials

## THERMOVEST MEN

**Sizes:** S - XXL

**Features:**

- \* multilayer Cross 6.0 back-protector, made of adaptive dual-density foam, EN-approved 1621-2
- \* innovative material-mix: extra-light light shell material combined with smart breathable thermo-padding
- \* removeable hood stormproof
- \* concealed chest pocket with zip & 2 concealed side-pockets

art. # 6351-207



# PROTECTION CASUAL





**HOODY**  
made of super-soft fleece,  
snugly & warm



**CROSS FLEX PROTECTOR**  
the safest protection -  
EN 1621-2



**KANGAROO  
POCKETS**



## FULL ZIP HOODY SHIRT WOMEN

**Sizes:** XXS - XL

**Features:**

- \* multilayer Cross FLEX back-protector, made of adaptive dual-density foam, EN-approved 1621-2
- \* made of comfortably fitting fleece
- \* 4-way stretch- material
- \* hood with draw-string
- \* integrated kidney-belt, adjustable with velcro fastener
- \* front zip

art. # 6356-240

## FULL ZIP SWEATER WOMEN

**Sizes:** XXS - XL

**Features:**

- \* multilayer Cross FLEX back-protector, made of adaptive dual-density foam, EN-approved 1621-2
- \* made of comfortably fitting fleece
- \* 4-way stretch- material
- \* Integrated kidney-belt, adjustable with velcro fastener
- \* front zip

art. # 6357-240

art. # 6357-209

# PROTECTION CASUAL



**4-WAY STRETCH LIGHT SHELL MATERIAL**  
for comfort



**CONCEALED SIDE BREAST POCKETS**  
with zip



**CONCEALED SIDE-POCKETS**  
with zip

**REMOVEABLE HOOD**  
fully customizable with draw-string and rubber cord



**INTEGRATED KIDNEY-BELT**  
adjustable with velcro-fastener



**BEST COLD & WIND PROTECTION**  
due to thermo-isolating, extra light technical materials

## THERMOVEST WOMEN

**Sizes:** XS - XL

**Features:**

- \* multilayer Cross 6.0 back-protector, made of adaptive dual-density foam, EN-approved 1621-2
- \* innovative material-mix: extra-light light shell material combined with smart breathable thermo-padding
- \* removeable hood stormproof
- \* concealed chest pocket with zip & 2 concealed side-pockets

art. # 6352-209



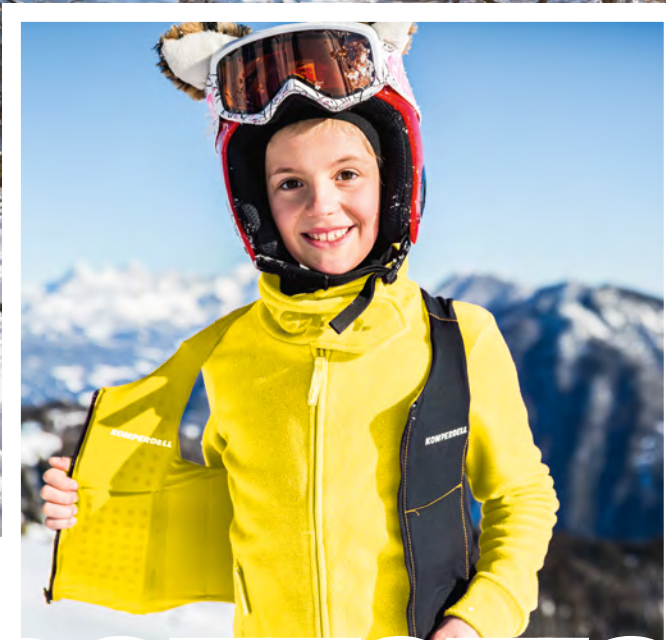

# PROTECTION

BECAUSE ONLY THE BEST PROTECTION IS GOOD ENOUGH FOR OUR KIDS

*360° protection and the highest protective properties on the market have won us multiple awards for our kid's protectors over the past 15 years.*





## **360° PROTECTION**

Most of our kid's protectors not only feature our award winning back protectors but additional layers of protective foam on the front and side. 360° of protection is something only KOMPERDELL offers.



## **WIDTH ADJUSTMENT**

New for the coming season is a specially designed side panel that gives the vest a ton of extra stretch on the side. Especially with kids choosing the right size of protector is key for the protector to perform properly.



## **CROSFLEX 6.0**

The remaining force of our new CrossFlex 6.0 protectors is up to 40 % lower than prior generations.

Their new multilayer design vastly improves the flexibility of our new generation of protectors. New 3D mesh inserts on the back improve their comfort and enhance the breathability.

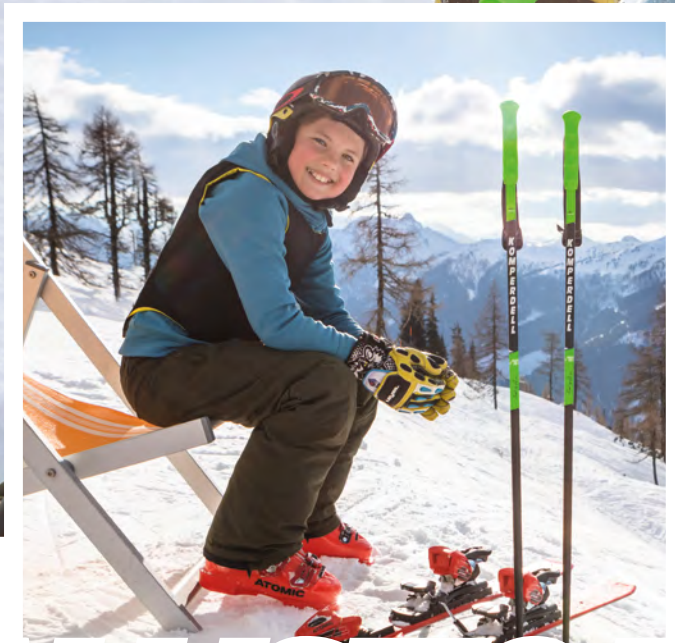

# **BALLISTIC PRO JUNIOR**

*ONLY THE BEST IS GOOD ENOUGH FOR YOUR KIDS*

*We are the only manufacturer who protects your child with 360° all around protection.*



**40% BETTER PROTECTION**

**CROSS 6.0 PROTECTOR**  
the safest protection – EN 1621-2  
**NEW FOR KIDS: level 2**

**AUTOMATIC WIDTH ADJUSTMENT**



**BALLISTIC FLEX FIT PRO JUNIOR**

**Sizes:** 116 - 152

**Features:**

- \* multilayer Cross 6.0 back-protector, made of adaptive dual-density foam, EN-approved 1621-2  
NEW: level 2
- \* 360° all around protection - top protection values
- \* automatic width adjustment
- \* extremely lightweight & breathable protector
- \* best safety values
- \* with front zipper – easier to put on and take off
- \* unlimited freedom of movement
- \* improved ergonomics

art. # 6457-212



**ISPO AWARD  
GOLD WINNER**  
2017/2018

# PROTECTION KIDS CORNER



**ULTIMATE  
FREEDOM OF MOVEMENT**  
for more fun in the snow



**ADDITIONAL  
RIB PROTECTORS**  
360° protection



## BALLISTIC VEST JUNIOR

**Sizes:** 116 - 152

**Features:**

- ★ multilayer Cross 6.0 Junior back protector made of adaptive dual-density foam, EN-approved 1621-2
- ★ 360° all around protection - top protection values
- ★ light and flexible



**ISPO AWARD  
WINNER**  
2016/2017

■ art. # 6321-208

■ art. # 6321-209

# PROTECTION KIDS CORNER





## AIR VEST JUNIOR

Sizes: 116 - 152

**Features:**

- ★ multilayer Cross 6.0 Junior back protector made of adaptive dual-density foam, EN-approved 1621-2
- ★ 360° all around protection - top protection values
- ★ light and flexible

■ art. # 6450-18

■ art. # 6452-243



## PRO SHORT JUNIOR

Sizes: 116 - 152

**Features:**

- ★ comfortable foam material for optimal protection of hips
- ★ slip-proof rubber band at waist and legs

art. # 6133-02



**ISPO AWARD  
WINNER**  
2016/2017

# RACING PROTECTION







## FLEX PACK

**Sizes:** Adult: XXS - XL  
Junior: 128 - 140 - 152

**Features:**

- ★ multilayer Cross 6.0 back-protector made of adaptive dual-density foam, EN-approved 1621-2
- ★ conforms to FIS regulations
- ★ anatomic shaped back part
- ★ new reshaped strap system for best fit – shoulder it like a backpack
- ★ protector insert visible – part of the design concept
- ★ ultimate freedom of movement
- ★ slim kidney belt for perfect fit, adjustable with velcro and plush

art. # 6362-213 Adult

art. # 6363-213 Junior



## PRO SHORT

**Sizes:** unisex, XS - XL

**Features:**

- ★ comfortable foam material for optimal protection of coccyx, thighs and hips
- ★ sporty look

art. # 6355-212



## **ELBOW PROTECTOR**

**Sizes:** S/M, L/XL

**Features:**  
\* EN-approved

**art. # 6361-02**



## **KNEE PROTECTOR**

**Sizes:** S/M, L/XL

**Features:**  
\* EN-approved

**art. # 6360-02**



# **RACING PROTECTION**

**KOMPERDELL**



**BACK PROTECTION**  
 multilayer Cross 6.0 protector  
 for perfect protection



### FULL PROTECTOR SLALOM SHIRT LONG

**Sizes:** Adult: XS - XL  
 Junior: 116 - 152

- Features:**
- \* perfect breathability, comfortable to wear
  - \* multilayer Cross 6.0 back-protector, made of adaptive dual-density foam, EN-approved 1621-2
  - \* perfect protection of back, shoulders, shoulderblades & arms

art. # 6301-208 Adult  
 art. # 6302-208 Junior



### PROTECTOR SLALOM SHIRT

**Sizes:** Adult: XS - XL  
 Junior: 116 - 152

- Features:**
- \* perfect breathability, comfortable to wear
  - \* body-shape cut
  - \* multilayer protectors made of dual-density foam
  - \* perfect protection of shoulders, shoulderblades and arms
  - \* specially shaped back for perfect combination with the FIS approved FlexPack

art. # 6283-02 Adult  
 art. # 6284-02 Junior



### STORMHOOD

**Sizes:** Junior/Adult

**Features:**

- ★ BC-Flex with rapid-dry function
- ★ 4-way stretch – extra elastic
- ★ perfect to be worn under helmet

art. # 6210-02 Adult

art. # 6211-02 Junior



### ARCTIC STORMHOOD

**Sizes:** unisex

**Features:**

- ★ BC-Flex with rapid-dry function
- ★ fleece/spandex material
- ★ warming hood for extra cold temperatures

art. # 6216-02



### ARCTIC SCARF

**Sizes:** unisex

**Features:**

- ★ fleece/spandex material
- ★ multifunctional headgear
- ★ to be used as scarf, cap or headband

art. # 6209-02



### FLEECE MASK

**Sizes:** Junior/Adult

**Features:**

- ★ fleece material
- ★ fully adjustable with velcro fastener

art. # 6212-02 Adult

art. # 6213-02 Junior



### NEOPRENE MASK

**Sizes:** Junior/Adult

**Features:**

- ★ neoprene material
- ★ fully adjustable with velcro fastener

art. # 694-02 Adult

art. # 603-02 Junior



### KNITTED NOSTALGIC CAP

**Sizes:** unisex

**Features:**

- ★ 100% soft acrylic
- ★ retro look – still a sales hit

□ art. # 602-1 white/red

■ art. # 602-2 black/red/retro

MERINO WOOL



### ALPINE MERINO

Sizes: XS - XXL

**Features:**

- \* seamless: wind- & waterproof
- \* breathable 4-layer material concept
- \* non slip & abrasion-resistant palm
- \* merino wool mix inside lining for optimal heat insulation

art. # 401-02

MERINO WOOL



### FREERIDE LIGHT

Sizes: XS - XXL

**Features:**

- \* seamless: wind- & waterproof
- \* breathable 4-layer material concept
- \* palm with abrasion-resistant kevlar-material
- \* merino wool mix inside lining for optimal heat insulation

art. # 447-02

BC FLEX  
outside lining



### TOURING BC FLEX

Sizes: XS - XXL

**Features:**

- \* seamless: wind- & waterproof
- \* 3-layer material concept
- \* odour-neutralizing & breathable
- \* humidity-absorbing
- \* palm with non-slip material
- \* comfortable soft brushed BC-Flex inside-lining
- \* extra light & thin material

art. # 410-02

TERRY CLOTH  
lining in- & outside



### TOURING FROTTEE

Sizes: XS - XL

**Features:**

- \* seamless: wind- & waterproof
- \* 3-layer material concept
- \* breathable & humidity-absorbing
- \* palm, with non-slip reinforced
- \* extra warm terry cloth lining for cold winter tours
- \* middle- and ring finger made of soft-shell material

art. # 411-03



### RACING GLOVE

Sizes: XS - XL

**Features:**

- \* genuine leather
- \* special heat insulation
- \* knuckles protection out of carbon
- \* shock absorbing foam on fingers, thumb and back of the hand

art. # 6501-02



### RACING LOBSTER

Sizes: XS - XL

**Features:**

- \* genuine leather
- \* special heat insulation
- \* knuckles protection out of carbon
- \* shock absorbing foam on fingers, thumb and back of the hand

art. # 6502-02

COVER →



### THERMO MITTENS

Sizes: S & L

**Features:**

- \* neoprene mitten to wear over a 5-finger glove
- \* optimal heat insulation in case of low temperatures
- \* multifunctional usage

art. # 405-02



### LEATHER GLOVES

Sizes: S [6,5]  
M [7,5]  
L [9]  
XL [10]

**Features:**

- \* genuine leather
- \* extra warm

art. # 441-02

**PROTECTION  
MOUNTAINBIKE**



# **MOUNTAINBIKE**

**MAXIMUM PROTECTION WITHOUT ADDITIONAL WEIGHT**

*While others work with a separate protector-plate, we are the only manufacturer who constructs the entire back section. Ergonomically perfectly fitting back protector with sufficient storage space and clever details.*



1



2

HELMET HOLDER



3

DRINK BOTTLE POCKET



INTEGRATED RAIN COVER



## MTB-PRO PROTECTORPACK

**Sizes:** unisex  
black/green; S - M - L  
black/blue; M - L  
black/malbec; S - M

### Features:

- ★ multilayer Cross 7.1 FB back protector made of adaptive dual-density foam, EN-approved 1621-2
- ★ Raincover included
- ★ lightweight and flexible
- ★ highest safety values
- ★ slim kidney belt for perfect fit
- ★ washable

### Optional:

- ★ BATTERYPACK  
padded pack for spare battery
- ★ NOTEBOOKCASE S - M - L  
padded pack for Pads/Notebooks
- ★ STORM JACKET XS - XL  
waterproof and breathable jacket

### Inclusive:

- ★ WATER RESERVOIR 2L
- ★ RAINCOVER

art. # 6348-02

art. # 6349-02

art. # 6350-02



art. # 6340-230



art. # 6338-213



art. # 6339-04



art. # 6342-206

# PROTECTION URBAN



## URBAN

PERFECTLY PROTECTED IN ANY WEATHER

*With our Urban Pack you are perfectly protected, regardless if the sun is shining or it is raining – with the integrated waterproof storm jacket you are prepared for any kind of weather.*





## URBAN PROTECTORPACK

**Sizes:** unisex  
XS - XL

**Features:**

- ★ multilayer Cross 7.1 FB back protector made of adaptive dual-density foam, EN-approved 1621-2
- ★ waterproof storm jacket included
- ★ lightweight and flexible
- ★ highest safety values
- ★ slim kidney belt for perfect fit
- ★ washable

art. # 6346-02

DRINK BOTTLE  
POCKET

INTEGRATED  
STORM JACKET  
instead of a  
conventional raincover



## NOTEBOOK CASE

**Sizes:** S - M - L

art. # 6349-02

**PROTECTION  
RENTAL**



# RENTAL

BECAUSE SAFETY HAS TOP PRIORITY  
IN RENTAL-BUSINESS

*The protector backpack can be washed at 30° without reducing the impact protection, it can sustain multiple crash-impacts. Therefore the protectors do not have to be replaced after a crash.*



## BATTERY PACK

padded pack for spare battery

art. # 6348-02

**Optional:**

- ★ WATERBLADDER
- ★ NOTEBOOKCASE S - M - L  
padded pack for Pads/Notebooks
- ★ STORM JACKET XS - XL  
waterproof and breathable jacket

**Inclusive:**

- ★ RAINCOVER

art. # 6371-10

art. # 6349-02

art. # 6350-02

HELMET HOLDER

DRINK BOTTLE  
POCKET



**CERTIFIED ACCORDING TO EN 1621-2**  
exceeds the requested secure value of Level 2  
by far

**HAND WASHABLE**



impact protection will be not reduced

**UNLIMITED MULTIPLE IMPACT PROTECTION**

need **not** to be changed after a crash

## MTB ECO / RENTAL PROTECTORPACK

**Sizes:** unisex  
black/green; S - M - L

**Features:**

- ★ multilayer Cross 7.1 FB back protector made of adaptive dual-density foam, EN-approved 1621-2
- ★ Raincover included
- ★ lightweight and flexible
- ★ highest safety values
- ★ slim kidney belt for perfect fit
- ★ washable
- ★ individual logo possible

art. # 6347-02



**OutDoor**  
by ISPO

Outstanding Outdoor

Gold Winner 2019

an ISPO Award

# FXP CARBON

**MOUNTAINEERING WAS NEVER EASIER!**

*Handling the FXP is as easy as it can be. The packed pole is held together by a Velcro strap and once opened, it unfolds completely by itself. This is not only easy, it also saves time and creates a unique experience.*

# THE FIRST AND ONLY SELF DEPLOYING FOLDING POLE



## SOLID MECHANICAL CONNECTION

no load on the push button

## PURE MAGIC - SELF DEPLOYING

when released, the pole deploys completely by itself

## FXP MECHANISM

Exclusively and only from Komperdell

## 30% LIGHTER

going from 11 to 3 parts in the folding system makes all the difference

AWARD WINNER

**OutDoor**  
by ISPO

Outstanding Outdoor

Gold Winner 2019

an ISPO Award



**TRAIL  
TEAM**

3 YEAR SERVICE  
NO QUESTIONS ASKED

3 YEAR SERVICE  
NO QUESTIONS ASKED

41 cm

38 cm

41 cm

38 cm

### CARBON CLOUD .FXP TEAM VARIO GREEN

**Sizes:** packed size: 41 cm  
115 - 135 cm  
(in 10cm steps)

**Weight:** 238g

**Features:**

- \* Trail Pro 245 cork grip
- \* Trail Click-In strap 2.1
- \* 4-sections:  
Carbon Ultralight, Ø 18/16mm
- \* Powerlock 3.0 locking mechanism
- \* FXP folding mechanism
- \* Trailstick carbide tip

OutDoor  
by ISPO  
Outstanding Outdoor

art. # 194 23 66-48

### CARBON CLOUD .FXP TEAM VARIO PINK

**Sizes:** packed size: 38 cm  
105 - 125 cm  
(in 10cm steps)

**Weight:** 230g (115cm)

**Features:**

- \* Trail Pro 245 cork grip
- \* Trail Click-In strap 2.1
- \* 4-sections:  
Carbon Ultralight, Ø 18/16mm
- \* Powerlock 3.0 locking mechanism
- \* FXP folding mechanism
- \* Trailstick carbide tip

OutDoor  
by ISPO  
Outstanding Outdoor

art. # 194 23 67-14

### CARBON .FXP TEAM VARIO GREEN FOLDABLE

**Sizes:** 105/115/125/135cm

**Weight:** 240g

**Features:**

- \* Trail Pro 245 cork grip
- \* Trail Click-In strap 2.1
- \* 3-sections:  
Carbon Ultralight, Ø 16 mm
- \* FXP folding mechanism
- \* Trailstick carbide tip

OutDoor  
by ISPO  
Outstanding Outdoor

art. # 194 23 59-48

### CARBON .FXP TEAM VARIO PINK FOLDABLE

**Sizes:** 105/115/125/135cm

**Weight:** 240g

**Features:**

- \* Trail Pro 245 cork grip
- \* Trail Click-In strap 2.1
- \* 3-sections:  
Carbon Ultralight, Ø 16 mm
- \* FXP folding mechanism
- \* Trailstick carbide tip

OutDoor  
by ISPO  
Outstanding Outdoor

art. # 194 23 60-14

**TRAIL  
FXP**







## CARBON.FXP TRAIL CLICK IN

**Sizes:** packed size: 41cm (115cm)  
105 - 135cm  
(in 10cm steps)

**Weight:** 211g (115cm)

### Features:

- \* Trail Pro 245 Foam grip
- \* Trail Click-In strap 2.1
- \* 3-sections:  
Carbon Composite, Ø 16 mm
- \* FXP folding mechanism
- \* Trailstick carbide tip

**OutDoor**  
by ISPO

Outstanding Outdoor

GOLD MEMBER 2011

art. # 194 23 50-10



## CARBON.FXP TRAIL

**Sizes:** packed size: 41cm (115cm)  
105 - 135cm  
(in 10cm steps)

**Weight:** 189g (115cm)

### Features:

- \* Trail Pro 245 Full Foam grip
- \* Comfort Padded strap
- \* 3-sections:  
Carbon Composite, Ø 16 mm
- \* FXP folding mechanism
- \* Trailstick carbide tip

**OutDoor**  
by ISPO

Outstanding Outdoor

GOLD MEMBER 2011

art. # 194 23 51-10

# PACK X-TRAIL





### X-TRAIL PACK GREEN

**Weight:** 460g with Jacket  
224g without Jacket

**Features:**

- ★ light, flexible & elastic material
- ★ Maximum freedom of breathing
- ★ Ultimate freedom of movement
- ★ Washable
- ★ Design made in Austria
- ★ Closures & straps individually adjustable
- ★ Pack can be enlarged to double the volumen

art. # 6397-208 XS/S  
art. # 6397-208 M/L



### X-TRAIL PACK PINK

**Weight:** 460g with Jacket  
224g without Jacket

**Features:**

- ★ light, flexible & elastic material
- ★ Maximum freedom of breathing
- ★ Ultimate freedom of movement
- ★ Washable
- ★ Design made in Austria
- ★ Closures & straps individually adjustable
- ★ Pack can be enlarged to double the volumen

art. # 6398-209 XS/S  
art. # 6398-209 M/L

# TREKKING FXP





### CARBON FXP.4 SUMMIT VARIO

**Sizes:** packed size: 41 cm  
adjustable from 115 - 135 cm

**Weight:** 238g

**Features:**

- \* Trek Pro cork 245 grip
- \* AIR Padded strap
- \* 4-sections:  
Carbon, Ø 18/16 mm
- \* Powerlock 3.0 mechanism
- \* FXP folding mechanism
- \* FXP-UL VARIO basket
- \* tungsten/carbide flex tip

**OutDoor**  
by ISPO  
Outstanding Outdoor  
2014 Winner 2015  
@ISPO Award

art. # 194 23 63-10



### CARBON FXP.4 SUMMIT VARIO COMPACT

**Sizes:** packed size: 38 cm  
adjustable from 105 - 125 cm

**Weight:** 237g

**Features:**

- \* Trek Pro cork 245 grip
- \* AIR Padded strap
- \* 4-sections:  
Carbon, Ø 18/16 mm
- \* Powerlock 3.0 mechanism
- \* FXP folding mechanism
- \* FXP-UL VARIO basket
- \* tungsten/carbide flex tip

**OutDoor**  
by ISPO  
Outstanding Outdoor  
2014 Winner 2015  
@ISPO Award

art. # 194 23 64-10



### CARBON FXP.4 APPROACH VARIO

**Sizes:** packed size: 41 cm  
adjustable from 115 - 135 cm

**Weight:** 247g

**Features:**

- \* Trek Pro Foam 245 grip
- \* Comfort Padded strap
- \* 4-sections:  
Carbon, Ø 18/16 mm
- \* Powerlock 3.0 mechanism
- \* FXP folding mechanism
- \* FXP-UL VARIO basket
- \* tungsten/carbide flex tip

**OutDoor**  
by ISPO  
Outstanding Outdoor  
2014 Winner 2015  
@ISPO Award

art. # 194 23 56-10



### CARBON FXP.4 APPROACH VARIO COMPACT

**Sizes:** packed size: 38 cm  
adjustable from 105 - 125 cm

**Weight:** 239g

**Features:**

- \* Trek Pro Foam 245 grip
- \* Comfort Padded strap
- \* 4-sections:  
Carbon, Ø 18/16 mm
- \* Powerlock 3.0 mechanism
- \* FXP folding mechanism
- \* FXP-UL VARIO basket
- \* tungsten/carbide flex tip

**OutDoor**  
by ISPO  
Outstanding Outdoor  
2014 Winner 2015  
@ISPO Award

art. # 194 23 57-10



**WOMEN  
EDITION**



**CALIMA  
CARBON CLOUD**

**Sizes:** packed size: 57 cm  
adjustable from 90 - 120 cm

**Weight:** 175 g

**Features:**

- \* Trek Pro Foam 280 cork grip
- \* AIR Padded strap
- \* 3-sections:  
top part: carbon cloud, Ø 18 mm  
middle part: carbon cloud, Ø 16 mm  
lower part: carbon cloud, Ø 14 mm
- \* Powerlock 3.0 mechanism
- \* Mini UL Vario basket
- \* tungsten/carbide flex tip

art. # 175 23 58-10



**BOREA  
CARBON PRO**

**Sizes:** packed size: 57 cm  
adjustable from 90 - 120 cm

**Weight:** 204 g

**Features:**

- \* Trek Pro Foam 280 cork grip
- \* AIR Padded strap
- \* 3-sections:  
top part: carbon, Ø 18 mm  
middle part: carbon, Ø 16 mm  
lower part: Titanal .HF, Ø 14 mm
- \* Powerlock 3.0 mechanism
- \* Mini UL Vario basket
- \* tungsten/carbide flex tip

art. # 175 23 59-10



**POWERLOCK 3.0**  
highly rigid, anodized  
aluminum for max.  
holding power!



**TRAMONTANA  
TI**

**Sizes:** packed size: 57 cm  
adjustable from 90 - 120 cm

**Weight:** 220 g

**Features:**

- \* Trek Pro 280 Foam grip
- \* Comfort Padded strap
- \* 3-sections:  
top part: aluminum 7075-T6, Ø 18 mm  
middle part: aluminum 7075-T6, Ø 16 mm  
lower part: aluminum 7075-T6, Ø 14 mm
- \* Powerlock 3.0 mechanism
- \* Mini UL Vario basket
- \* tungsten/carbide flex tip

art. # 174 23 56-10

# CARBON C3 CLOUD



*The lightest poles on the market!*





**3** YEAR SERVICE  
NO QUESTIONS ASKED



**CARBON .C3  
CLOUD**

**Sizes:** packed size: 67 cm  
adjustable from 105 - 140 cm

**Weight:** 187 g

**Features:**

- \* Trek Pro 280 Foam cork grip
- \* AIR Padded strap
- \* 3-sections:  
carbon cloud, Ø 18/16/14 mm
- \* Powerlock 3.0 mechanism
- \* Mini UL Vario basket
- \* tungsten/carbide flex tip

art. # 175 23 68-10

**3** YEAR SERVICE  
NO QUESTIONS ASKED



**40% LIGHTER**  
than conventional poles

**CARBON .C3  
CLOUD COMPACT**

**Sizes:** packed size: 57 cm  
adjustable from 90 - 120 cm

**Weight:** 175 g

**Features:**

- \* Trek Pro 280 Foam cork grip
- \* AIR Padded strap
- \* 3-sections:  
carbon cloud, Ø 18/16/14 mm
- \* Powerlock 3.0 mechanism
- \* Mini UL Vario basket
- \* tungsten/carbide flex tip

art. # 175 23 69-10

**CARBON**  
C3





**3** YEAR SERVICE  
NO QUESTIONS ASKED

**CARBON .C3  
PRO**

**Sizes:** packed size: 67 cm  
adjustable from 105 - 140 cm

**Weight:** 221g

**Features:**

- \* Trek Pro 280 Foam grip
- \* Comfort Padded strap
- \* 3-sections:  
top part: carbon, Ø 18 mm  
middle part: carbon, Ø 16 mm  
lower part: Titanal .HF, Ø 14 mm
- \* Powerlock 3.0 mechanism
- \* Mini UL Vario basket
- \* tungsten/carbide flex tip

art. # 175 23 60-10



**3** YEAR SERVICE  
NO QUESTIONS ASKED

**CARBON .C3  
PRO COMPACT**

**Sizes:** packed size: 57 cm  
adjustable from 90 - 120 cm

**Weight:** 201g

**Features:**

- \* Trek Pro 280 Foam grip
- \* Comfort Padded strap
- \* 3-sections:  
top part: carbon, Ø 18 mm  
middle part: carbon, Ø 16 mm  
lower part: Titanal .HF, Ø 14 mm
- \* Powerlock 3.0 mechanism
- \* Mini UL Vario basket
- \* tungsten/carbide flex tip

art. # 175 23 61-10



**3** YEAR SERVICE  
NO QUESTIONS ASKED

**CARBON .C3  
PRO**

**Sizes:** packed size: 67 cm  
adjustable from 105 - 140 cm

**Weight:** 213 g

**Features:**

- \* Trek Pro 150 Foam grip
- \* Comfort Padded strap
- \* 3-sections:  
top part: carbon, Ø 18 mm  
middle part: carbon, Ø 16 mm  
lower part: Titanal .HF, Ø 14 mm
- \* Powerlock 3.0 mechanism
- \* Mini UL Vario basket
- \* tungsten/carbide flex tip

art. # 175 23 70-10



**3** YEAR SERVICE  
NO QUESTIONS ASKED

**CARBON .C3  
PRO COMPACT**

**Sizes:** packed size: 57 cm  
adjustable from 90 - 120 cm

**Weight:** 197 g

**Features:**

- \* Trek Pro 150 Foam grip
- \* Comfort Padded strap
- \* 3-sections:  
top part: carbon, Ø 18 mm  
middle part: carbon, Ø 16 mm  
lower part: Titanal .HF, Ø 14 mm
- \* Powerlock 3.0 mechanism
- \* Mini UL Vario basket
- \* tungsten/carbide flex tip

art. # 175 23 71-10



# TITANAL EXPLORER



### EXPLORER CONTOUR POWERLOCK

**Sizes:** packed size: 65 cm  
adjustable from 105 - 140 cm

**Weight:** 239 g

**Features:**

- \* Trek Pro Foam 280 cork grip
- \* Comfort padded strap
- \* Alu 7075-T6, 3-sections Ø 18/16/14 mm
- \* Powerlock 3.0 mechanism
- \* Mini UL Vario basket
- \* tungsten/carbide flex tip



art. # 174 23 18-10



### EXPLORER COMPACT POWERLOCK

**Sizes:** packed size: 57 cm  
adjustable from 90 - 120 cm

**Weight:** 220 g

**Features:**

- \* Trek Pro Foam 280 cork grip
- \* Comfort padded strap
- \* Alu 7075-T6, 3-sections Ø 18/16/14 mm
- \* Powerlock 3.0 mechanism
- \* Mini UL Vario basket
- \* tungsten/carbide flex tip



art. # 174 23 16-10



### EXPLORER CONTOUR POWERLOCK

**Sizes:** packed size: 65 cm  
adjustable from 105 - 140 cm

**Weight:** 239 g

**Features:**

- \* Trek Pro Foam 280 grip
- \* Comfort padded strap
- \* Alu 7075-T6, 3-sections Ø 18/16/14 mm
- \* Powerlock 3.0 mechanism
- \* Mini UL Vario basket
- \* tungsten/carbide flex tip



art. # 174 23 14-10



### EXPLORER COMPACT POWERLOCK

**Sizes:** packed size: 57 cm  
adjustable from 90 - 120 cm

**Weight:** 220 g

**Features:**

- \* Trek Pro Foam 280 grip
- \* Comfort padded strap
- \* Alu 7075-T6, 3-sections Ø 18/16/14 mm
- \* Powerlock 3.0 mechanism
- \* Mini UL Vario basket
- \* tungsten/carbide flex tip



art. # 174 23 15-10

# TREKKING ALUMINUM



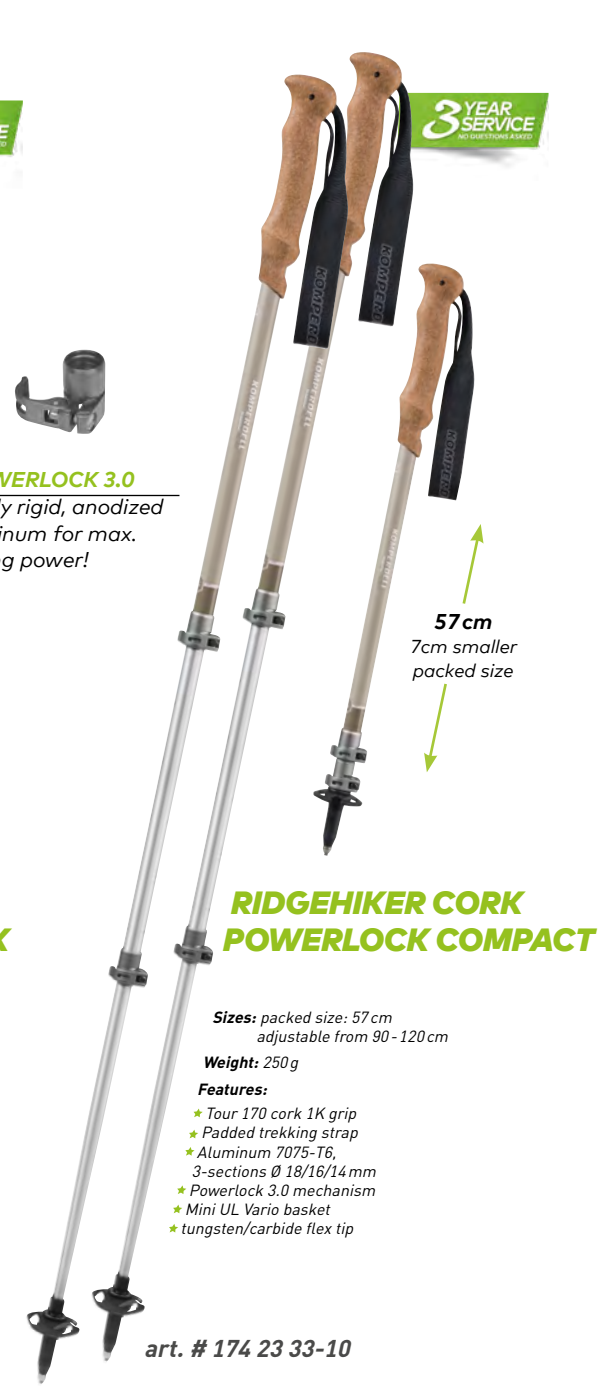
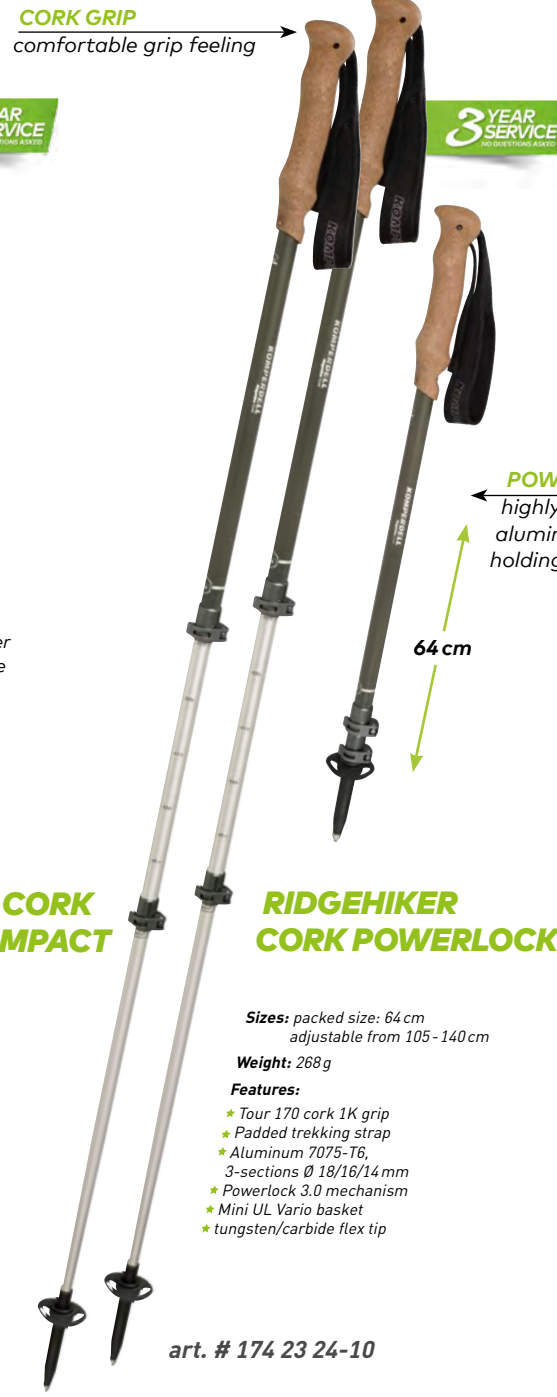
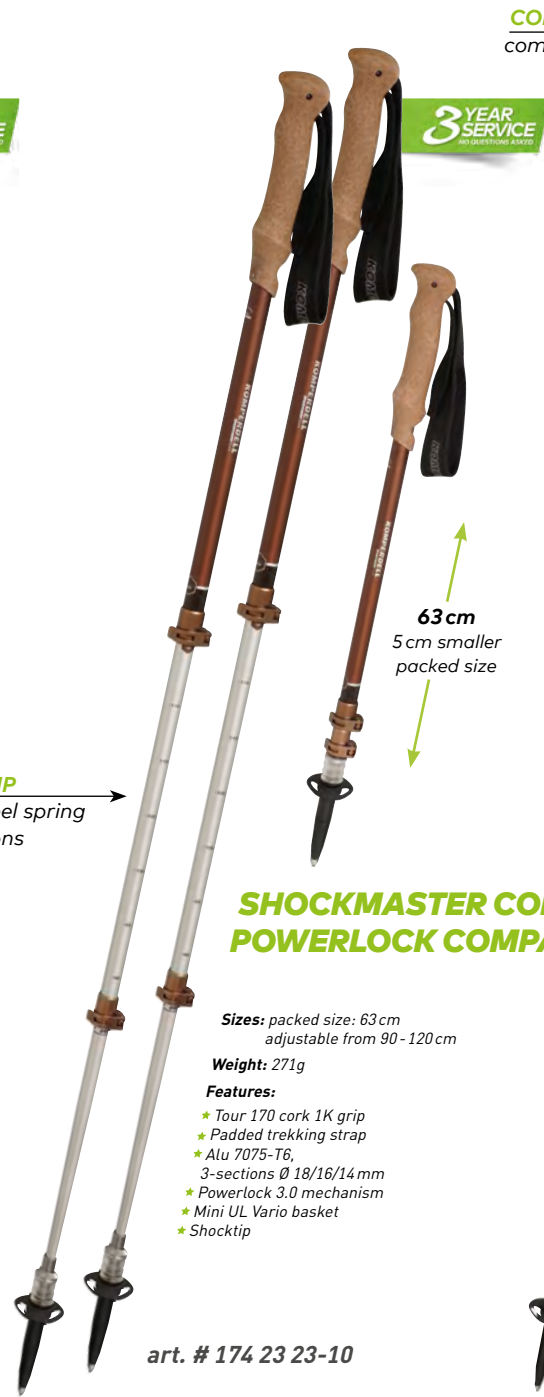
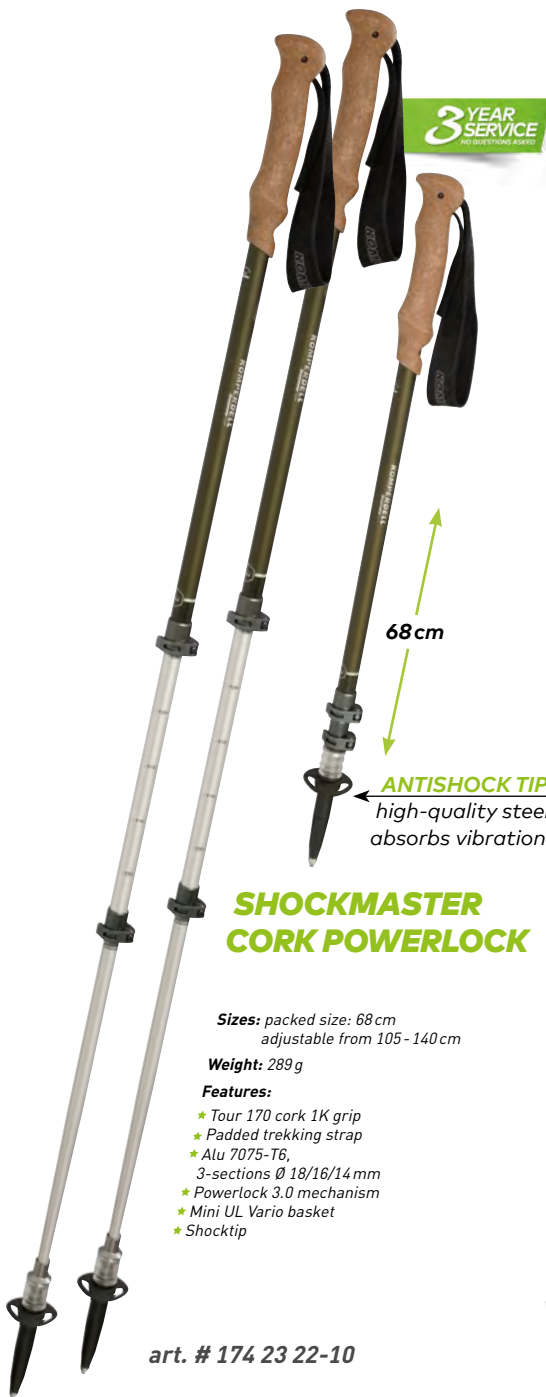

# TREKKING ALUMINUM





3 YEAR SERVICE  
NO QUESTIONS ASKED

64 cm

### TREKMASTER POWERLOCK

Sizes: packed size: 64 cm  
adjustable from 105 - 140 cm

Weight: 271 g

Features:

- \* EVA Foam grip
- \* system strap XL
- \* Aluminum 7075-T6,  
3-sections Ø 18/16/14 mm
- \* Powerlock 3.0 mechanism
- \* Mini UL Vario basket
- \* tungsten/carbide flex tip

art. # 174 23 31-10

3 YEAR SERVICE  
NO QUESTIONS ASKED

57 cm  
7cm smaller  
packed size

### TREKMASTER POWERLOCK COMPACT

Sizes: packed size: 57 cm  
adjustable from 90 - 120 cm

Weight: 252 g

Features:

- \* EVA Foam grip
- \* system strap XL
- \* Aluminum 7075-T6,  
3-sections Ø 18/16/14 mm
- \* Powerlock 3.0 mechanism
- \* Mini UL Vario basket
- \* tungsten/carbide flex tip

art. # 174 23 32-10

3 YEAR SERVICE  
NO QUESTIONS ASKED

66 cm

### HIGHLANDER CORK

Sizes: packed size: 66 cm  
adjustable from 105 - 140 cm

Weight: 248 g

Features:

- \* cork 170 1K grip
- \* system strap XL
- \* Aluminum 7075-T6,  
3-sections Ø 18/16/14 mm
- \* Twist Lock mechanism
- \* Mini UL Vario basket
- \* tungsten/carbide flex tip

art. # 174 23 28-10

3 YEAR SERVICE  
NO QUESTIONS ASKED

65 cm

### WILD RAMBLER

Sizes: packed size: 65 cm  
adjustable from 105 - 140 cm

Weight: 239 g

Features:

- \* Tour 170 PE 1K grip
- \* system strap
- \* Aluminum 7075-T6,  
3-sections Ø 18/16/14 mm
- \* Twist Lock mechanism
- \* Mini UL Vario basket
- \* steel tip

art. # 174 23 30-10

# TREKKING JUNIOR





### PEAK HUNTER JUNIOR POWERLOCK

**Size:** packed size: 74 cm  
adjustable from 90 - 125 cm

**Weight:** 218 g

**Features:**

- \* Tour 170 PE 1K grip
- \* system strap
- \* aluminum 7075-T6, 2-sections Ø 16/14 mm
- \* Powerlock 3.0 mechanism
- \* Mini UL Vario basket
- \* flex steel tip

art. # 164 23 13-10



### TRAILBLAZER KIDS GREEN

**Size:** packed size: 65 cm  
adjustable from 80 - 105 cm

**Weight:** 173 g

**Features:**

- \* race grip junior
- \* standard strap
- \* upper part: aluminum 7075-T6, Ø 16 mm
- \* lower part: aluminum 5083, Ø 14 mm
- \* Twist Lock mechanism
- \* Mini UL Vario basket
- \* steel tip

art. # 164 23 14-10

# TREKKING SINGLE STAFF



### CAMERA MOUNT SYSTEM

easily unscrew the cork head to mount your camera.



## TRAVEL & WADING STAFF .FXP VARIO

**Size:** packed size: 45cm  
adjustable from 115 - 135cm

#### Features:

- \* Full Foam Traveller Griff 245 mit Camera Mount System
- \* Ergo strap
- \* 4-sections:  
Carbon Composite, Ø 18/16mm
- \* Powerlock 3.0 mechanism
- \* FXP folding mechanism
- \* Trailstick carbide tip

art. # 196 23 05-10

3 YEAR SERVICE  
NO QUESTIONS ASKED

3 YEAR SERVICE  
NO QUESTIONS ASKED

45cm



## CARBON .FXP WALKING STAFF

**Size:** packed size: 36cm (95cm)  
85 - 105cm  
(in 10cm steps)

#### Features:

- \* cork walker grip
- \* Walker strap
- \* 3-sections:  
Carbon Composite, Ø 16/9mm
- \* FXP folding mechanism
- \* Trailstick carbide tip

art. # 196 23 04-10

3 YEAR SERVICE  
NO QUESTIONS ASKED

36cm

### CAMERA MOUNT SYSTEM

easily unscrew the cork head to mount your camera.



## CAMERA STAFF

**Sizes:** packed size: 73cm  
adjustable from 115 - 150cm

**Weight:** 294 g

#### Features:

- \* detachable camera cork grip 380 with camera mount system
- \* Ergo strap
- \* Aluminum 7075-T6,  
3-sections Ø 18/16/14mm
- \* Powerlock 3.0 mechanism
- \* Mini UL Vario basket
- \* tungsten/carbide flex tip

art. # 176 23 00-10

3 YEAR SERVICE  
NO QUESTIONS ASKED

73cm

# WALKING SINGLE STAFF



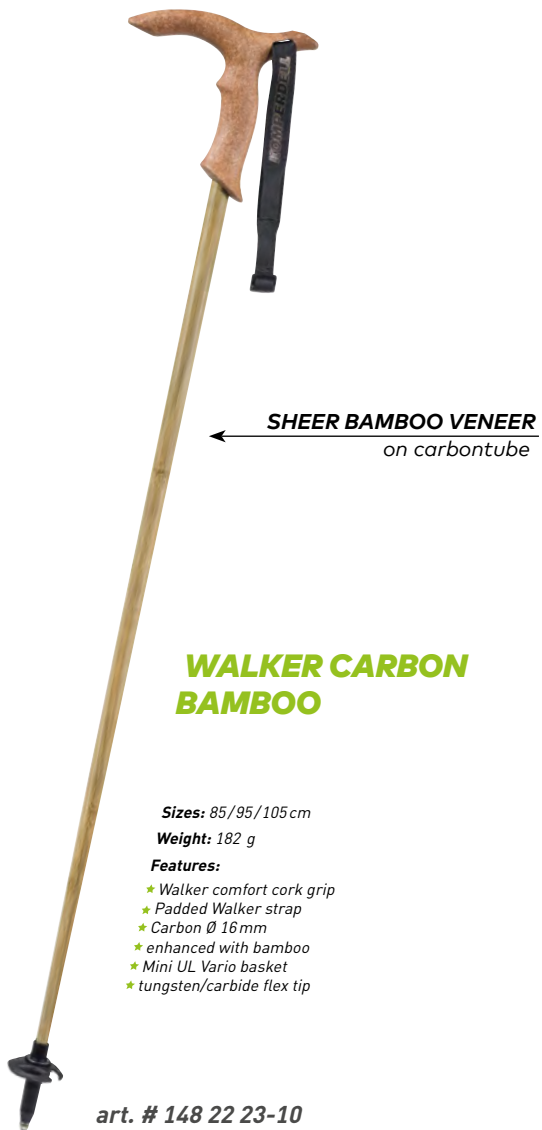

# NORDIC WALKING CARBON





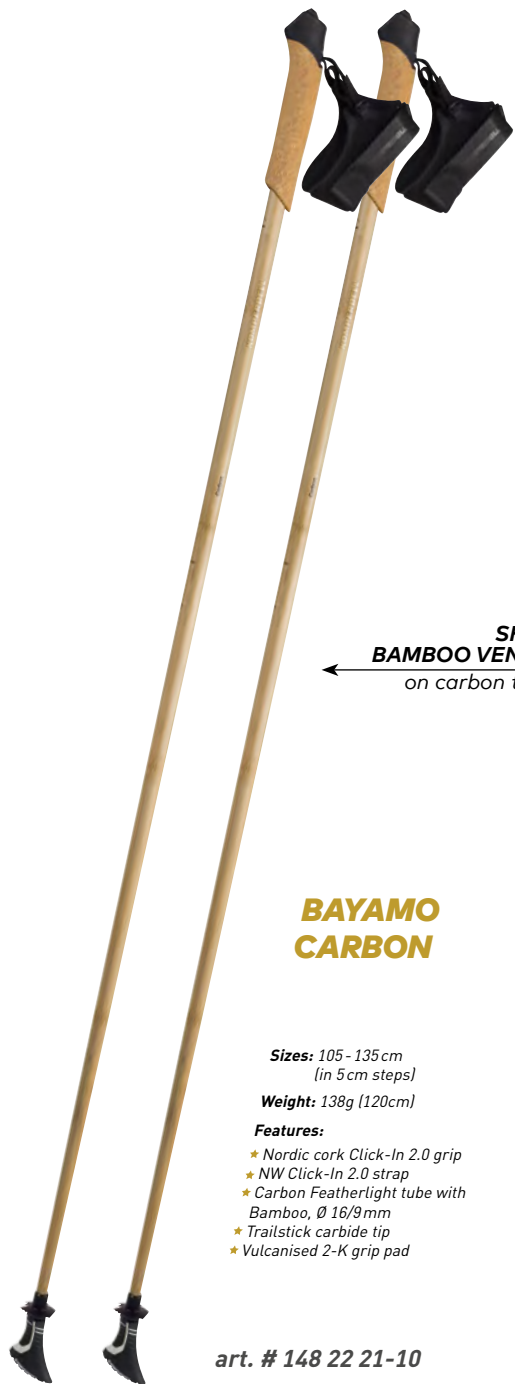

**BAYAMO  
CARBON**

**Sizes:** 105 - 135 cm  
(in 5 cm steps)

**Weight:** 138g (120cm)

**Features:**

- ★ Nordic cork Click-In 2.0 grip
- ★ NW Click-In 2.0 strap
- ★ Carbon Featherlight tube with Bamboo, Ø 16/9mm
- ★ Trailstick carbide tip
- ★ Vulcanised 2-K grip pad

art. # 148 22 21-10

← **CORK GRIP**  
sweat-absorbing  
and light →

← **SHEER  
BAMBOO VENEER**  
on carbon tube

← **NEW CLICK-IN SYSTEM**  
much easier to handle and it  
locks with a distinct **\*Click\*** →



**LEVANTE  
CARBON**

**Sizes:** 105 - 135 cm  
(in 5 cm steps)

**Weight:** 129g (120cm)

**Features:**

- ★ Nordic cork Click-In 2.0 grip
- ★ NW Click-In 2.0 strap
- ★ Carbon Featherlight tube, Ø 16/9mm
- ★ Trailstick carbide tip
- ★ Vulcanised 2-K grip pad

■ art. # 148 23 39-10 pure  
□ art. # 148 23 39-01 pearl



**PONIENTE  
CARBON**

**Sizes:** 105 - 135 cm  
(in 5 cm steps)

**Weight:** 174g (120cm)

**Features:**

- ★ NW EVA UL grip Click-In
- ★ NW Click-In 2.0 strap
- ★ Carbon Composite, Ø 16/9mm
- ★ Trailstick carbide tip
- ★ Vulcanised 2-K grip pad

■ art. # 148 23 34-10 pure  
□ art. # 148 23 34-01 pearl

**NW PADS**

art. # 1029-925



art. # 1028-925

# NORDIC WALKING VARIO



**3 YEAR SERVICE**  
NO QUESTIONS ASKED

41cm

**TRAVELLER.FXP FOLDABLE**

**Sizes:** packed size: 41cm (115cm)  
105 - 135cm  
(in 10cm steps)

**Weight:** 221g

**Features:**

- \* Nordic EVA UL Click-In grip
- \* NW Click-In 2.0 strap
- \* 3-sections:  
Carbon Composite, Ø 16 mm
- \* FXP folding mechanism
- \* Trailstick carbide tip
- \* Vulcanized 2K grip pad

**OutDoor**  
by ISPO  
Outstanding Outdoor  
Total Member Since 2001  
art. # 194 23 58-10



**3 YEAR SERVICE**  
NO QUESTIONS ASKED

98cm

**BAYAMO CARBON VARIO**

**Sizes:** packed size: 98cm  
adjustable from 105 - 125cm

**Weight:** 175g

**Features:**

- \* Nordic cork Click-In 2.0 grip
- \* NW Click-In 2.0 strap
- \* Carbon,  
2-sections Ø 16/14 mm
- \* Powerlock 3.0 mechanism
- \* Trailstick carbide tip
- \* Vulcanised 2-K grip pad

**POWERLOCK 3.0**  
highly rigid, anodized aluminum for max. holding power!

art. # 175 22 16-10



**3 YEAR SERVICE**  
NO QUESTIONS ASKED

98cm

**PONIENTE CARBON VARIO**

**Sizes:** packed size: 98cm  
adjustable from 105 - 125cm

**Weight:** 174g

**Features:**

- \* Nordic EVA UL Click-In grip
- \* NW Click-In strap 2.0
- \* Carbon,  
2-sections Ø 16/14 mm
- \* Powerlock 3.0 mechanism
- \* Trailstick carbide tip
- \* Vulcanised 2-K grip pad

art. # 175 23 62-10

## NW PADS



art. # 1028-925



**NW PADS**



art. # 1029-925



art. # 1028-925

# PRE-PACKED ACCESSORIES ARE ALSO AVAILABLE



**VARIO  
SUMMER BASKET**

art. # 9356-925



**RACE BASKET**

art. # 9352-925



**RACE BASKET  
EXTRA SMALL**

art. # 9379-925



**VARIO  
WINTER BASKET**

art. # 9364-925



**VARIO  
WINTERBASKET XL**

art. # 9912-925



**VARIO DEEP  
POWDER BASKET**

art. # 9908-925



**TRAILSTICK BASKET**

art. # 1016-925



**TIP PROTECTOR**

Ø 8mm: art. # 192-925  
Ø 12mm: art. # 190-925



**TIP PROTECTOR**

Ø 8mm: art. # 162-925  
Ø 12mm: art. # 161-925



**NORDIC WALKING PADS**

black/silver: art. # 1007-203  
grey/silver: art. # 1007-01



**NORDIC WALKING PADS**

black: art. # 1028-925  
light grey: art. # 1029-925

# THE NEW GENERATION OF BASKETS, STRAPS AND PRE-PACKAGING!



## NORDIC SPEED CLICK IN 2.0 STRAP

- S: art. # 7017-S-925
- M: art. # 7017-M-925
- L: art. # 7017-L-925



## LARGE UL ICE-FLEX BASKET

art. # 9950-925



## REGULAR UL ICE-FLEX BASKET

art. # 9949-925



## REGULAR UL ICE-FLEX FXP BASKET

art. # 9952-925



## MINI UL BASKET

art. # 9942-925



## REGULAR UL BASKET

art. # 9948-925



## NORDIC WALKING CLICK IN 2.0 STRAP

- XS: art. # 7014-XS-925
- S: art. # 7014-S-925
- M: art. # 7014-M-925
- L: art. # 7014-L-925



## TRAIL CLICK IN 2.1 STRAP

- XS: art. # 7018-XS-925
- S: art. # 7018-S-925
- M: art. # 7018-M-925
- L: art. # 7018-L-925



## MINI UL VARIO BASKET

art. # 9943-925



## REGULAR UL VARIO BASKET

art. # 9944-925



## LARGE UL VARIO BASKET

art. # 9951-925



## REGULAR UL VARIO FXP BASKET

art. # 9953-925

## EXCHANGEABLE BASKETS FOR VARIO BASKET SYSTEM



**VARIO SUMMER BASKET**  
Ø 8,5cm art. # 9356



**VARIO WINTER BASKET**  
Ø 8,5cm: art. # 9364



**VARIO WINTER BASKET XL**  
Ø 10cm: art. # 9912



**VARIO DEEP POWDER BASKET**  
Ø 13,5cm: art. # 9908



**MINI UL VARIO BASKET**  
Ø 5 cm: art. # 9943



**REGULAR UL VARIO BASKET**  
Ø 7cm: art. # 9944



**REGULAR UL VARIO FXP BASKET**  
Ø 7cm: art. # 9953



**LARGE UL VARIO BASKET**  
Ø 10,5cm: art. # 9951

## BASKETS FOR ICE-FLEX SYSTEM



**ICE-FLEX-SYSTEM**  
the simply brilliant moveable basket construction in combination with our ice-flex-tip



**TUBE-COLLAR FOR ICE-FLEX SYSTEM**  
art. # 146



**REGULAR UL ICE-FLEX BASKET**  
Ø 7cm: art. # 9949



**REGULAR UL ICE-FLEX FXP BASKET**  
Ø 7cm: art. # 9952



**LARGE UL ICE-FLEX BASKET**  
Ø 10,5cm: art. # 9950



**XC SPEED BASKET**  
art. # 9384

## BASKETS FOR STANDARD TIPS & PLUGS



**RACE BASKET**  
Ø 6cm: art. # 9352



**RACE BASKET XS**  
Ø 5cm: art. # 9379



**DOWNHILL BASKET**  
art. # 9383



**MINI UL BASKET**  
Ø 5 cm: art. # 9942



**REGULAR UL BASKET**  
Ø 7cm: art. # 9948

# STRAPS



**ALPINE RACE STRAP**  
art. # 7304



**PADDED STRAP**  
art. # 7342



**SYSTEM STRAP**  
art. # 7307

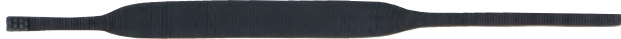

**SYSTEM STRAP XL**  
art. # 7308



**LEATHER STRAP**  
with embossed logo: art. # 7313-2K



**JUNIOR STRAP**  
art. # 7303



**STANDARD STRAP**  
art. # 7301



**WALKER PADDED STRAP**  
art. # 7305



**POWDER / POWDER PADDED STRAP**

Powder art. # 7350  
Powder Padded: art. # 7023



New Strap System

**COMFORT / COMFORT PADDED STRAP**

Comfort: art. # 7021  
ComfortPadded: art. # 7022

# NORDIC & NORDIC WALKING STRAPS



**NORDIC SPEED CLICK-IN 2.0 STRAP**  
available in following sizes:  
S - M - L  
art. # 7017



**NORDIC WALKING CLICK-IN 2.0 STRAP**  
available in following sizes:  
XS - S - M - L  
art. # 7014



**TRAIL CLICK-IN 2.1 STRAP**  
available in following sizes:  
XS - S - M - L  
art. # 7018



**NORDIC PADDED STRAP**  
art. # 7310



**NORDIC CLASSIC STRAP**  
art. # 7331

## FLEX TIPS FOR VARIO BASKET SYSTEMS



**ICE-FLEX  
TUNGSTEN/  
CARBIDE  
TIP**

Ø 9mm, standard version:  
art. # 145



**VARIO TUNGSTEN/  
CARBIDE FLEX TIP**

Ø 9mm: art. # 178  
for POWERLOCK:  
Ø 9mm: art. # 99



**VARIO TUNGSTEN/  
CARBIDE FLEX  
TIP SHORT**

Ø 9mm: art. # 193  
for POWERLOCK:  
Ø 9mm: art. # 174



**NORDIC VARIO  
TUNGSTEN/  
CARBIDE TIP**

Ø 9mm: art. # 1015



**VARIO PLUG**

art. # 108

## FLEX TIPS FOR STANDARD BASKETS



**TUNGSTEN/  
CARBIDE  
FLEX TIP  
SHORT**

Ø 9mm: art. # 160



**TUNGSTEN/  
CARBIDE FLEX  
TIP SHORT**

Ø 9mm: art. # 96



**BASKET  
FIXING  
PLUG**

art. # 101



**TUBE COLLAR**

art. # 100



**ALLOY PLUG**

art. # 106





# NORDIC WALKING, TRAIL & WALKER TIPS



**TRAILSTICK TIP**

with tungsten/carbide hollow tip:  
 Ø 9mm: art. # 1022



**TIP PROTECTOR**

Ø 8mm: art. # 192  
 Ø 12mm: art. # 190



**NORDIC WALKING CLASSIC COLOR PAD**

Ø 12mm black: art. # 1007-203



**NORDIC/BC TOURING BASKET**

with steel tip:  
 art. # 9375



**NORDIC TREK ULTRALIGHT BASKET**

holebasket  
 with tungsten/carbide tip:  
 Ø 9mm: art. # 9941



**NORDIC TRAIL ULTRALIGHT TELLER**

with tungsten/carbide tip:  
 Ø 9mm: art. # 9938



**XC TELLER**

with steel tip:  
 art. # 9361

# ADJUSTING MECHANISM



**POWERLOCK 3.0**

18/16mm: art. # 1291  
 16/14mm: art. # 1292



**POWERLOCK 2.1**

18/16mm: art. # 1280  
 16/14mm: art. # 1282



**TUBE COLLAR**

Ø 16mm: art. # 1302  
 Ø 18mm: art. # 1301



**THREADED PART**

Ø 14mm: art. # 1209  
 Ø 16mm: art. # 1207



**EXPANDING NUT**

Ø 14mm: art. # 1210  
 Ø 16mm: art. # 1208



**THREADED PART TITANAL.HF**

Ø 14mm: art. # 1272  
 Ø 16mm: art. # 1274



**EXPANDING NUT TITANAL.HF**

Ø 14mm: art. # 1273  
 Ø 16mm: art. # 1275

## ALPINE, TOURING & TREKKING GRIPS



### LEATHER GRIP CLASSIC

Ø 16mm: art. # 8854



### RACE DUPLO GRIP

Ø 12,3mm: art. # 8073  
Ø 13mm: art. # 8079  
Ø 16mm: art. # 8549



### LIGHTNING DUPLO GRIP

Ø 13mm: art. # 8047  
art. # 8038



### LIGHTNING TOUR DUPLO GRIP

Ø 13mm: art. # 8101



### FOAM EXPEDITION SHORT GRIP

Ø 18mm: art. # 8010-02  
Ø 20mm: art. # 8166-02



### FOAM ALPINE GRIP

Ø 18mm: art. # 8784



### TOURING GRIP

PE, race Ø 18mm: art. # 8321

### TOURING GRIP SYSTEM

rubber, race Ø 18mm: art. # 8179  
rubber, race Ø 13mm: art. # 8183  
PU, race Ø 18mm: art. # 8180

### RACE GRIP RUBBER LIME-GREEN

Ø 16mm: art. # 8264  
Ø 18mm: art. # 8818  
Ø 19mm: art. # 8233



### COMPACT GRIP SYSTEM

PU, Ø 13mm: art. # 8214  
PU, Ø 18mm: art. # 8239  
PU, Ø 19mm: art. # 8256  
PE, Ø 18mm: art. # 8241  
rubber, Ø 18mm: art. # 8238  
Cork, Ø 18mm: art. # 8239-255



### COMPACT GRIP STANDARD

PE:  
Ø 18mm: art. # 8728



### WALKER COMFORT GRIP

Cork:  
Ø 16mm: art. # 8773-255  
Ø 18mm: art. # 8764-255

## JUNIOR & KIDS GRIPS



### SABRE GRIP KIDS

Ø 14mm: art. # 8082  
Ø 16mm: art. # 8042



### JUNIOR JET GRIP

Ø 13mm: art. # 8220  
Ø 14mm: art. # 8234  
Ø 16mm: art. # 8236



### JUNIOR GRIP

PE:  
Ø 14mm: art. # 8206  
PU:  
Ø 16mm: art. # 8734



### KIDS RACE GRIP

PE:  
Ø 14mm: art. # 8182  
Ø 16mm: art. # 8181  
PU:  
Ø 16mm: art. # 8320



**TREK 170  
GRIP**

PE - Ø 16mm: **art. # 8165**  
 Cork - Ø 18mm: **art. # 8130-255**  
 Rubber - Ø 18mm: **art. # 8130-02**



**FOAM 280  
GRIP**

Ø 16mm: **art. # 8159**  
 Ø 18mm: **art. # 8135**



**PISTOL 2K  
GRIP**

Ø 13mm: **art. # 8317**  
 Ø 16mm: **art. # 8318**  
 Ø 18mm: **art. # 8319**



**2K TOURING FOAM 280  
GRIP**

Ø 16mm: **art. # 8306-202A** black-orange  
**art. # 8306-212B** black-silver  
 Ø 18mm: **art. # 8307-212B** black-silver



**2K TOURING FOAM 450  
GRIP**

Ø 16mm: **art. # 8308-202A**



**FOAM PISTOL 120  
GRIP**

Ø 13mm: **art. # 8313**  
 Ø 16mm: **art. # 8314**

**NORDIC & NORDIC WALKING GRIPS**



**NORDIC 2K CLICK-IN 2.0  
GRIP**

Ø 16mm: **art. # 8184**



**NORDIC 2K CLICK-IN 2.0  
GRIP**

Ø 16mm, FOAM: **art. # 8177**



**XC  
GRIP**

without CLICK-IN  
 FOAM:  
 Ø 16mm: **art. # 8721**  
 Ø 18mm: **art. # 8738**



**XC CLASSIC  
GRIP**

PE:  
 Ø 16mm: **art. # 8004-02**  
 Cork:  
 Ø 16mm: **art. # 8004-225**



# POS MATERIALS



## PROTECTION BIKE DEMO BOARD

### Features:

- ★ 55x90 cm
- ★ Kapa material 5 mm
- ★ removable protector insert
- ★ with optional hook to fix on cloth rail

art. # 6261-207

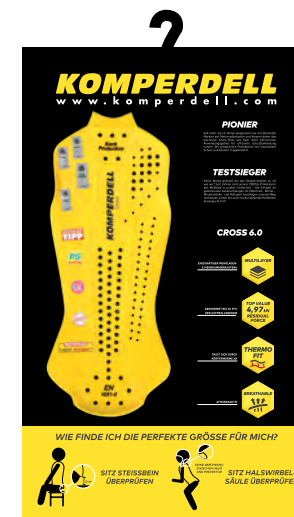

## PROTECTION SKI CROSS 6.0 DEMO BOARD

### Features:

- ★ 55x90 cm
- ★ Kapa material 5 mm
- ★ removable protector insert
- ★ with optional hook to fix on cloth rail

art. # 6256-206



## PROTECTION SKI CROSS FLEX DEMO BOARD

### Features:

- ★ 60x78 cm
- ★ Kapa material 5 mm
- ★ removable protector insert
- ★ with optional hook to fix on cloth rail

art. # 6255-202



## DEMO BALLISTIC VEST ON TORSO

### Features:

- ★ technique of the Ballistic Vest
- ★ consists of torso, Ballistic Vest and Pro Short

art. # 6254-206



## DISPLAY MANNEQUINS & TORSI

- Males mannequin: art. # 2080-99
- Ladies mannequin: art. # 2081-99
- Junior mannequin: art. # 2082-99
- Male torso: art. # 2083-99
- Female torso: art. # 2084-99





## IMPACT TEST MACHINE GONDOLA DOUBLE

### Features:

- \* 2270x1700x625mm
- \* power and individual air connection will be needed (oxygen tank possible)
- \* incl. clothes rail for protectors
- \* removable protector insert

art. # 6545-10



## IMPACT TEST MACHINE GONDOLA SINGLE

### Features:

- \* 1735x1700x625mm
- \* power and individual air connection will be needed (oxygen tank possible)
- \* incl. clothes rail for protectors

art. # 6544-10

**KOMPERDELL**  
www.komperdell.com

## CLOUD CARBON

Die leichtesten Alpinstöcke am Markt –  
40% weniger Gewicht

ULTRA  
LEICHT  
AB 138 GRAMM

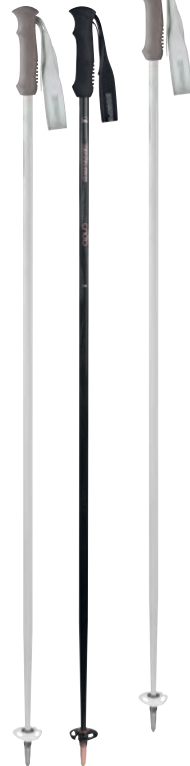

### CLOUD DISPLAY

- ★ Size: 36x180cm
- ★ to hang up or to line up
- ★ Instore Display for pole series "CLOUD" with digital scale

art. # 56-99

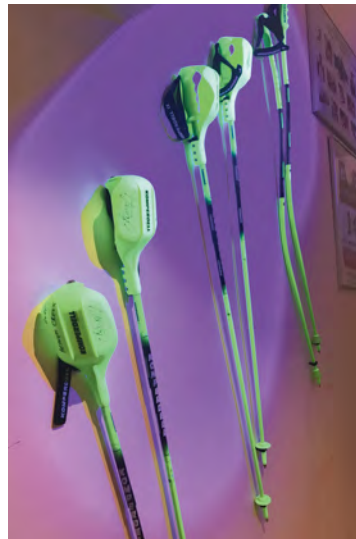

### BLACK LIGHT PRESENTATION FOR NATIONALTEAM POLES

- ★ 60W
- ★ 1,5m cable length
- ★ easy assembly
- ★ consisting of lamp, mount, plug and remote
- ★ appropriate for shop window, order fair, showrooms, highlight/product presentation

art. # 6456-10



### MONITOR DISPLAY SMALL 10 INCH

Space-saving display for corporate and product videos for a holistic and customer-friendly product presentation.

Size 24.5 x 16.9 CM  
Resolution 1920 x 1080

art. # 6579-10

### MONITOR DISPLAY BIG 15 INCH

Elegant display for company and product videos for a holistic and customer-friendly product presentation.

Size 34.1 x 27.3 cm  
Resolution 1024x768

art. # 6580-10



### TEAM VEST MEN

Sizes: XS-XL

- ★ innovative material-mix: extra-light light shell material combined with smart breathable thermo-padding
- ★ removeable hood stormproof

art. # 6344-02



### TEAM VEST WOMEN

Sizes: XS-L

- ★ innovative material-mix: extra-light light shell material combined with smart breathable thermo-padding
- ★ removeable hood stormproof

art. # 6345-02

# POS MATERIAL

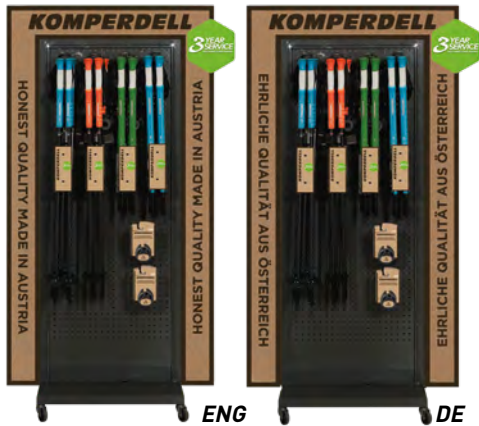

**POLE DISPLAY**

- Features:**
- ★ Instore display for Trekking- and Alpine poles
  - ★ made of strong aluminum
  - ★ with wheels
  - ★ perfect for any shop
  - ★ includes 12 hooks

art. # 56-999



**DISPLAY HENRIK KRISTOFFERSEN**

- Features:**
- ★ life-sized shop display
  - ★ 190 cm height
  - ★ real poles can be fixed on the display
  - ★ poles not included in the price

art. # 54-999



**LOGO BANNER**

- Features:**
- ★ 200 x 70 cm
  - ★ fully eyed and seamed
  - ★ perfect for promotion to hang into shop windows, in the window, on fences etc.

■ art. # 35-48 ■ art. # 35-29



**POLE DISPLAY MADE OF MASSIV WOOD**

- Features:**
- ★ for 16 pairs of poles (without poles)
  - ★ for 8 pairs of poles (without poles)

art. # 181-25

art. # 431-25



**LOT BOX**

- Features:**
- ★ 59x86x36 cm (with drawer 84x86x36cm, measured without poles)
  - ★ Instore display for 25 pairs of telescopic or fixed length poles
  - ★ made of cardboard
  - ★ 4 drawers included for accessories
  - ★ perfect for every shop

art. # 57-999



**POLE PACKAGING**

Ø 16mm: art. # 2328-16  
Ø 18mm: art. # 2328-18



**BEACHFLAGS**

- Features:**
- ★ padded transportation bag
  - ★ base plate 18x30x0,6 cm for indoor use or bolt for outdoor use

total height 250cm      total height 450cm  
■ art. # 34-48      ■ art. # 29-48  
■ art. # 34-29      ■ art. # 29-29



**HEADQUARTERS MONDSEE**

**KOMPERDELL GmbH**

Wagnermühle 30

5310 Mondsee • Austria

phone: +43/6232/4201-0

fax: +43/6232/3545

e-mail: [sales@komperdell.com](mailto:sales@komperdell.com)

[www.komperdell.com](http://www.komperdell.com)

**DISTRIBUTION NORTH AMERICA**

**CAMARO USA, LLC**

22737 72<sup>nd</sup> Avenue S, Suite C-103

Kent, WA 98032 • USA

phone: +1 253-867-57 35

fax: +1 253-867-57 34

e-mail: [sales-usa@camaro.at](mailto:sales-usa@camaro.at)

[www.komperdell.com](http://www.komperdell.com)

**KOMPERDELL**  
[www.komperdell.com](http://www.komperdell.com)



[komperdell.outdoor.sport](https://www.facebook.com/komperdell.outdoor.sport)



[komperdell\\_official](https://www.instagram.com/komperdell_official)



[Komperdell](https://www.youtube.com/Komperdell)